

BD-24 Metal Connector

New BD-24 (M24 type) series waterproof connector, adopts streamlined dynamic design, one-button device end pressing and rapid plugging, in order to prevent the use of end due to manual operation improper key failure factors can effectively increase the service life of the product.

Precise internal construction and strong metal shell structure provide safe and stable connection and transmission performance, and guarantee the stability of electrical performance during the use of the equipment



Wide range application fast locking connector

BD-24 series power and signal waterproof connectors can be used alone or fixed together to provide solutions for different industries equipment connection. Such as audio-visual equipment, medical equipment, industrial control, testing and measurement Equipment, AV system, broadcast television and communication industry and other fields. Suitable for connection of equipment installed in front and behind the board.

Product application:

Power supply: 3pin

Signal: RJ45

Working voltage up to 500V, rated current 25A, optional shielding connector.

- Multi-pin
Power Cable Range: $\phi 10.5 \sim \phi 12 \text{mm}$
- RJ45 series
Cable Range: $\phi 5.5 \sim \phi 7.0 \text{mm}$



Characteristics

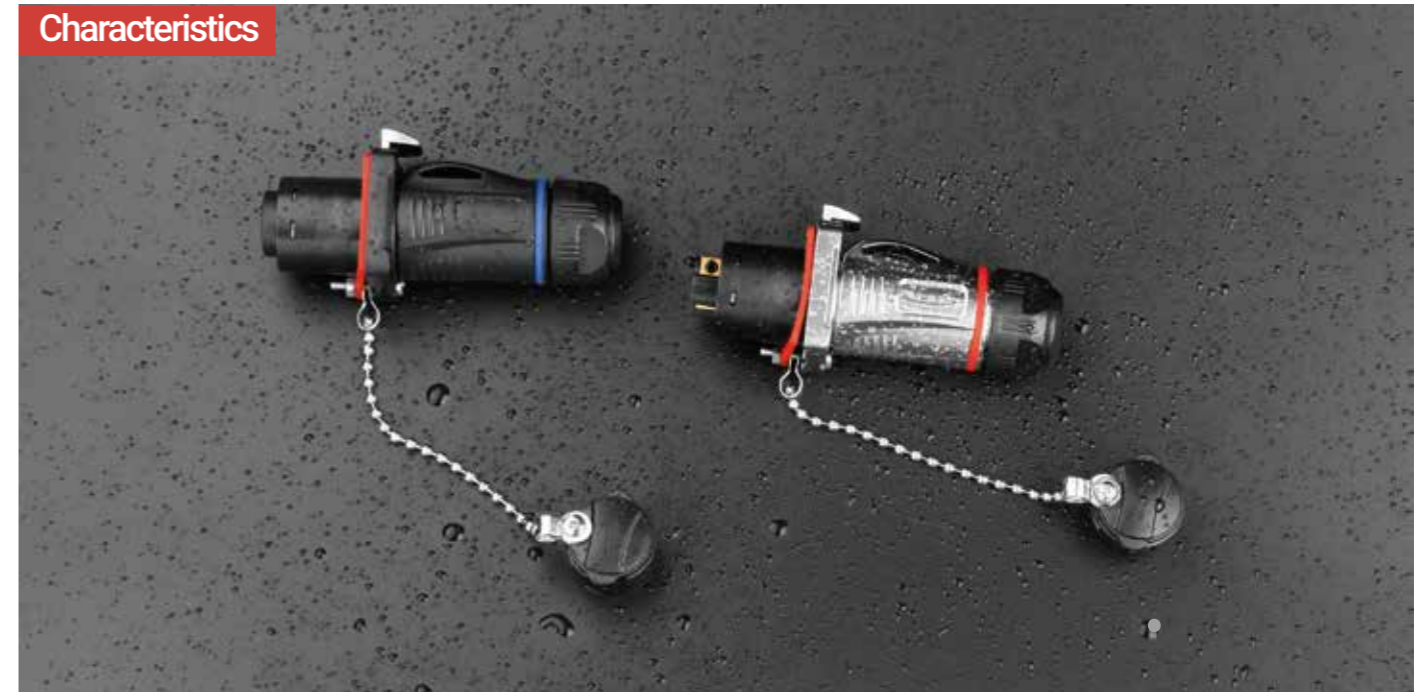

Reliable waterproof

- When connecting, the protection level is up to IP67, providing good electrical protection performance for the equipment.



Termination

- BD-24 is with screw type connection



Multiple protection designs

- Metal /plastic shell design, various choices, perfect for various application scenarios .



Ergonomic shape design

- The appearance adopts integrated streamlined design













Power with board mounting



RJ45 with board mounting

BD-24 Data Sheet

M24 Power + Signal	Product Series	BD-24		
	Pin Number	3PIN		RJ45
	Section diagram	PIN 	Mounting 	
	Current Rating	25A		
	Voltage Rating	AC 500V		
	Cable range	Ø10.5~Ø12.0mm		Ø5.5~Ø7.0mm
	Wire Gauge	2.5~4.0mm ² /14-12AWG		26-24AWG
	IP Protection Class (Mated)	IP67 (Mated)		
	Termination	Screw Locking		
Product Picture	material	Part Number		
	Plastic	Male	BD-24-C03PE-22-001	—
		Female	BD-24-J03SX-22-201	—
		Male	—	BD-24-C/RJ45/015/PE-42-001
		Female	—	BD-24-J/RJ45/213/SX-42-201
	Metal	Male	BD-24-C03PE-23-001	—
		Female	BD-24-J03SX-23-201	—
		Male	—	BD-24-C/RJ45/015/PE-43-001
		Female	—	BD-24-J/RJ45/213/SX-43-201

Appearance Dimension

■ Cable connector

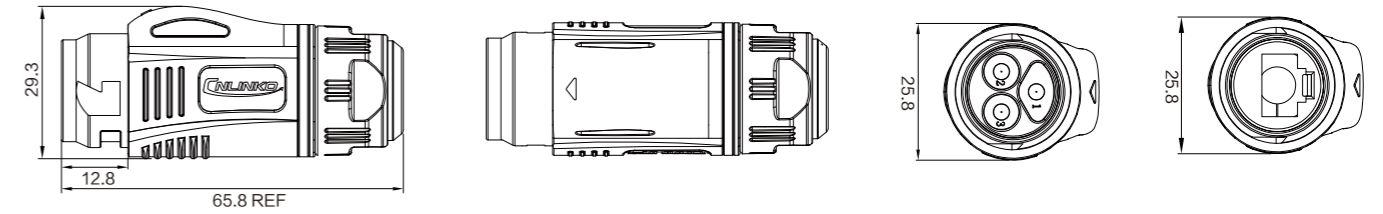

■ Power Flange Panel Mounting

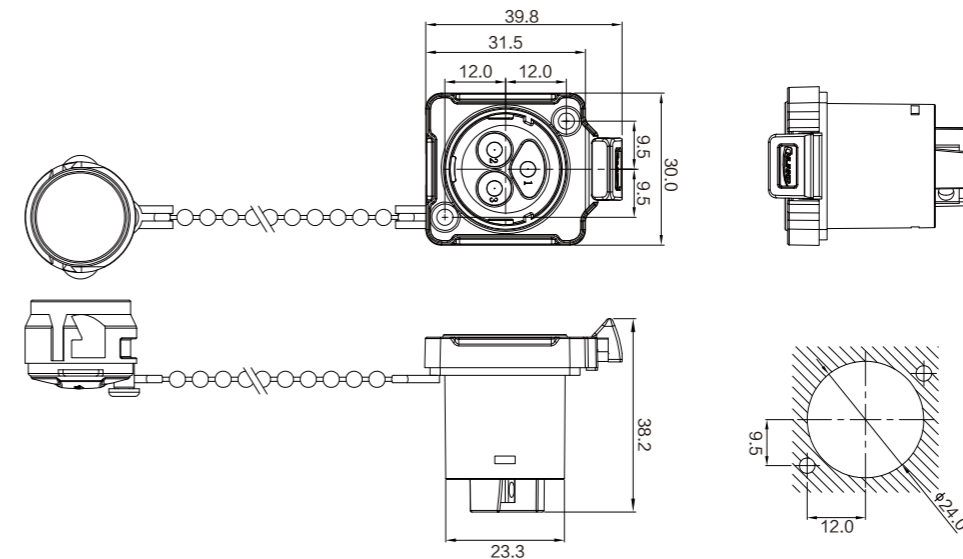

■ RJ45 Flange Panel Mounting

