



# Technical Data Sheet

## Chip LED with Bi-Color(Multi-Color)

**19-22/R6G6C-A01/2T**

### Feature

- Package in 8mm tape on 7" diameter reel.
- Compatible with automatic placement equipment.
- Compatible with infrared and vapor phase reflow solder process.
- Multi-color type.
- Pb-free.
- The product itself will remain within RoHS compliant version.



### Descriptions

- The 19-22 SMD Taping is much smaller than lead frame type components, thus enable smaller board size, higher packing density, reduced storage space and finally smaller equipment to be obtained.
- Besides, lightweight makes them ideal for miniature applications etc.

### Applications

- Backlighting in dashboard and switch.
- Telecommunication: indicator and backlighting in telephone and fax.
- Flat backlight for LCD, switch and symbol.
- General use.

### Device Selection Guide

Chip			Lens Color
Type	Material	Emitted Color	
R6	AlGaInP	Brilliant Red	Water Clear
G6	AlGaInP	Brilliant Yellow Green	

**Package Outline Dimensions**

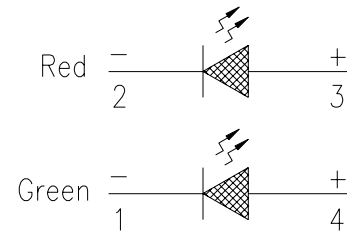
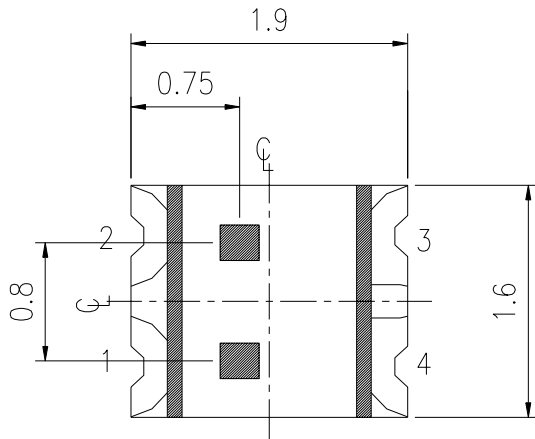

Polarity

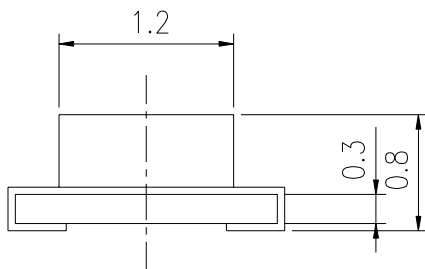

For reflow soldering

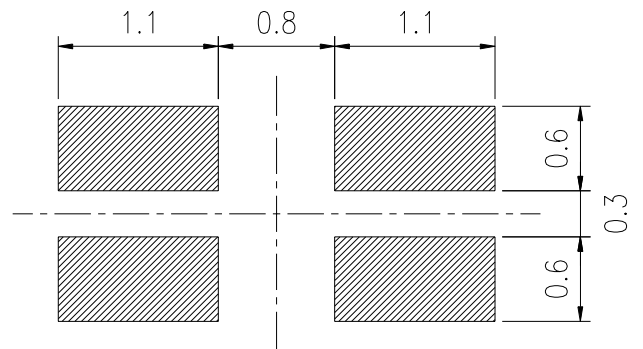
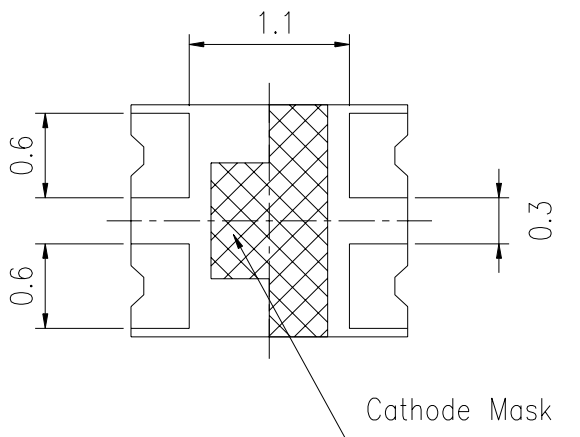

**Note:** The tolerances unless mentioned is  $\pm 0.1\text{mm}$  ,Unit = mm

**Absolute Maximum Ratings (Ta=25°C)**

Parameter	Symbol	Rating	Unit
Reverse Voltage	V <sub>R</sub>	5	V
Forward Current	I <sub>F</sub>	25	mA
Peak Forward Current (Duty 1/10 @1KHz)	I <sub>FP</sub>	60	mA
Power Dissipation	P <sub>d</sub>	60	mW
Electrostatic Discharge (HBM)	ESD	2000	V
Operating Temperature	T <sub>opr</sub>	-40 ~ +85	°C
Storage Temperature	T <sub>stg</sub>	-40 ~ +90	°C
Soldering Temperature	T <sub>sol</sub>	Reflow Soldering : 260 °C for 10 sec. Hand Soldering : 350 °C for 3 sec.	

**Electro-Optical Characteristics (Ta=25°C)**

Parameter	Symbol	Min.	Typ.	Max.	Unit	Condition
Luminous Intensity	I <sub>v</sub>	R6 45.0	----	72.0	mcd	I <sub>F</sub> =20mA
	G6 45.0	----	72.0			
Viewing Angle	2θ 1/2	-----	130	-----	deg	
Peak Wavelength	λ <sub>p</sub>	R6 -----	632	-----	nm	
	G6 575	-----	575			
Dominant Wavelength	λ <sub>d</sub>	R6 617.5	-----	633.5	nm	
	G6 567.5	-----	575.5			
Spectrum Radiation Bandwidth	△λ	R6 -----	20	-----	nm	
	G6 20	-----	20			
Forward Voltage	V <sub>F</sub>	R6 1.7	2.0	2.4	V	
	G6 1.7	1.7	2.0	2.4		
Reverse Current	I <sub>R</sub>	R6 -----	-----	10	μA	V <sub>R</sub> =5V
	G6 10	-----	-----	10		

**Notes:**

- 1.Tolerance of Luminous Intensity ±10%
- 2.Tolerance of Dominant Wavelength ±1nm

**R6**
**Bin Range Of Luminous Intensity**

Bin	Min	Max	Unit	Condition
P1	45.0	57.0	mcd	I <sub>F</sub> =20mA
P2	57.0	72.0		

**G6**
**Bin Range Of Luminous Intensity**

Bin	Min	Max	Unit	Condition
P1	45.0	57.0	mcd	I <sub>F</sub> =20mA
P2	57.0	72.0		

**R6**
**Bin Range Of Dom. Wavelength**

Group	Bin	Min	Max	Unit	Condition
A	E4	617.5	621.5	nm	I <sub>F</sub> =20mA
	E5	621.5	625.5		
	E6	625.5	629.5		
	E7	629.5	633.5		

**G6**
**Bin Range Of Dom. Wavelength**

Group	Bin	Min	Max	Unit	Condition
B	C15	567.5	569.5	nm	I <sub>F</sub> =20mA
	C16	569.5	571.5		
	C17	571.5	573.5		
	C18	573.5	575.5		

**Notes:**

- 1.Tolerance of Luminous Intensity  $\pm 10\%$
- 2.Tolerance of Dominant Wavelength  $\pm 1\text{nm}$

**Typical Electro-Optical Characteristics Curves**

**R6**

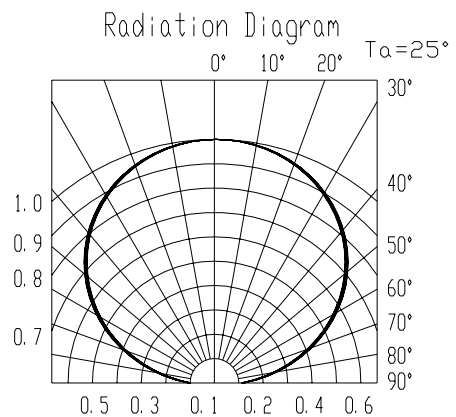
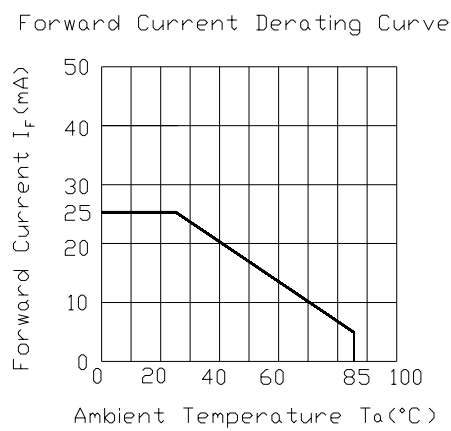
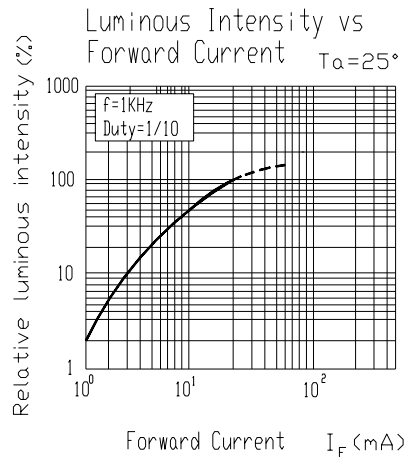
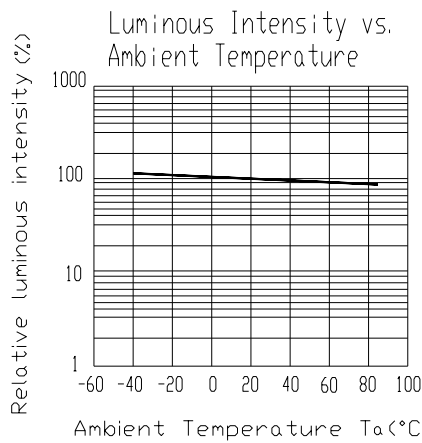
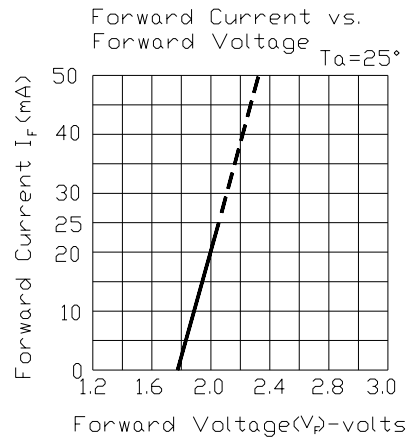
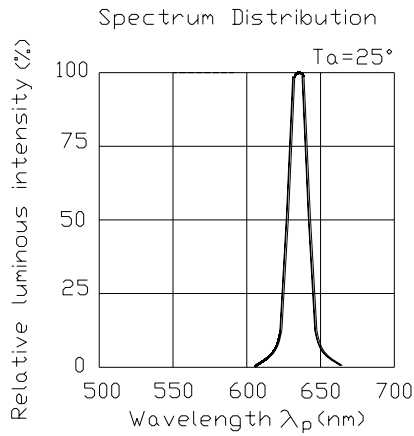

**Typical Electro-Optical Characteristics Curves**

G6

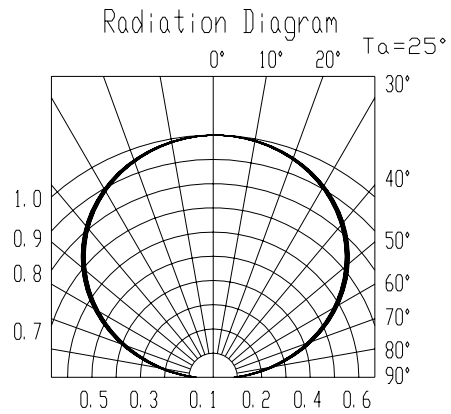
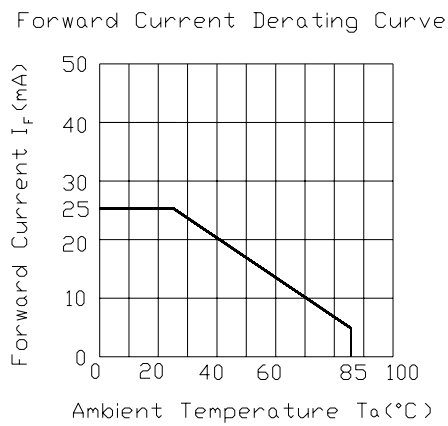
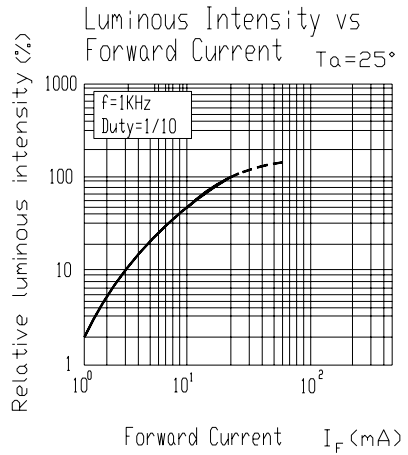
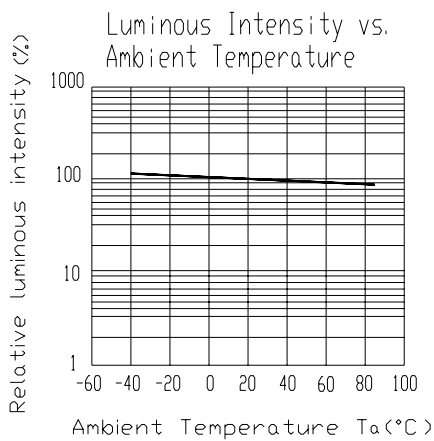
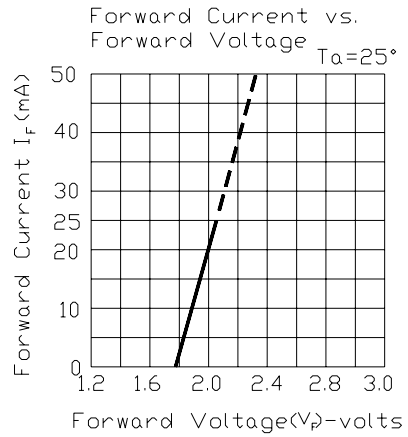
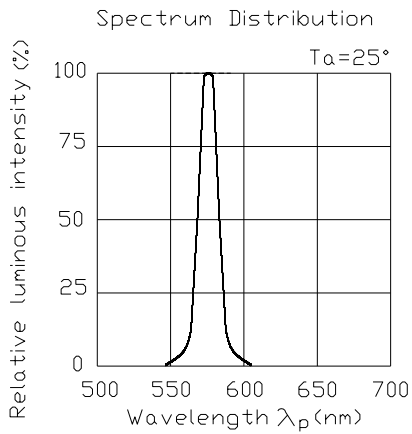

**Label explanation**

**CAT: Luminous Intensity Rank**

**HUE: Dom. Wavelength Rank**

**REF: Forward Voltage Rank**

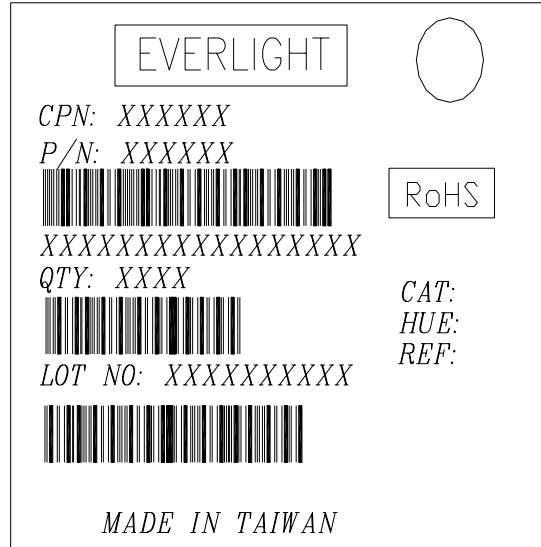

**Reel Dimensions**

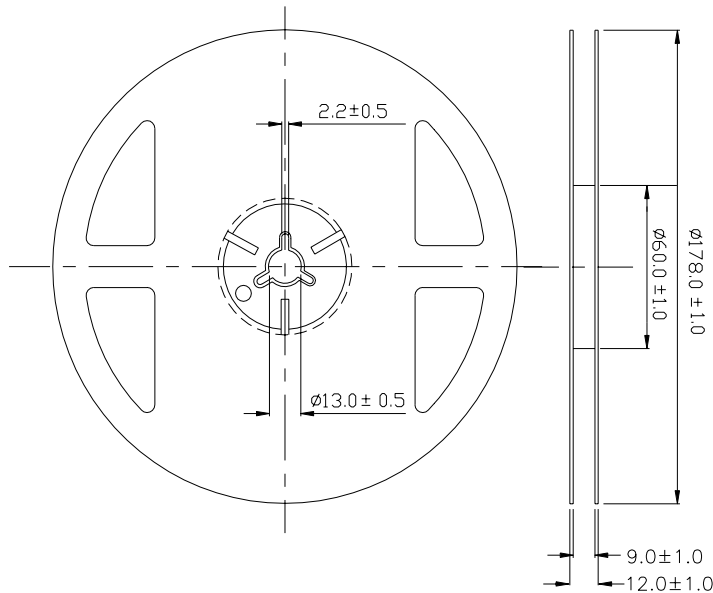

**Note:** The tolerances unless mentioned is  $\pm 0.1\text{mm}$ , Unit = mm



**Carrier Tape Dimensions: Loaded quantity 2000 PCS per reel**

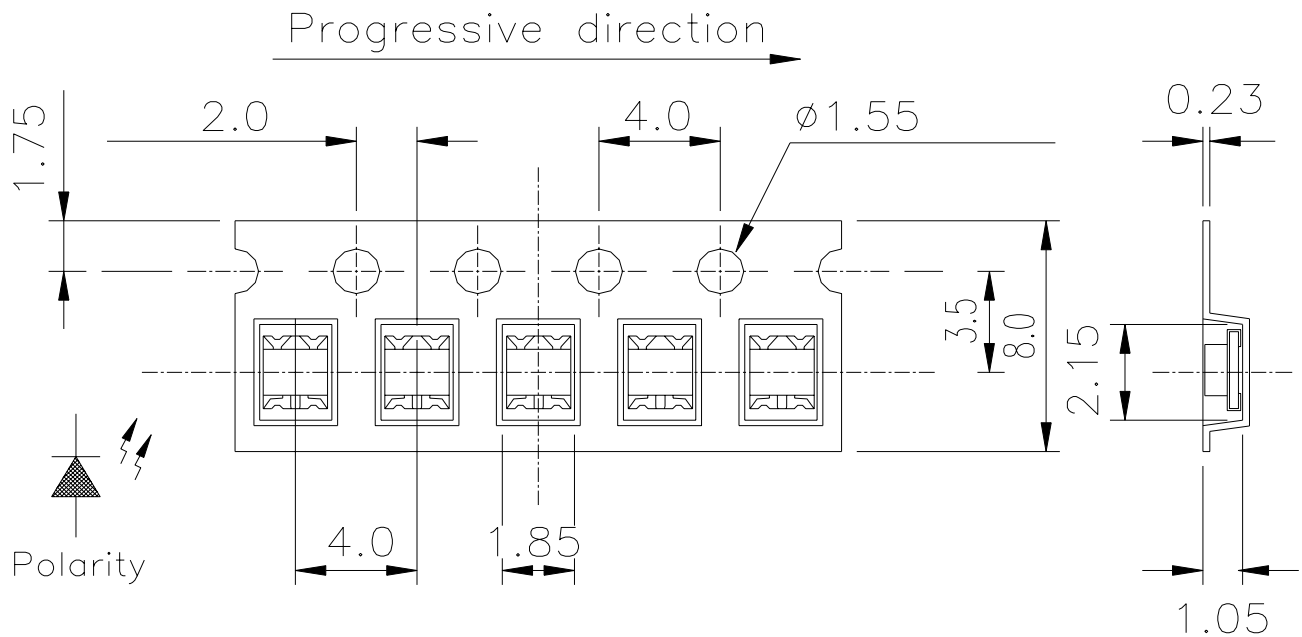

**Note:** The tolerances unless mentioned is  $\pm 0.1$ mm ,Unit = mm

**Moisture Resistant Packaging**

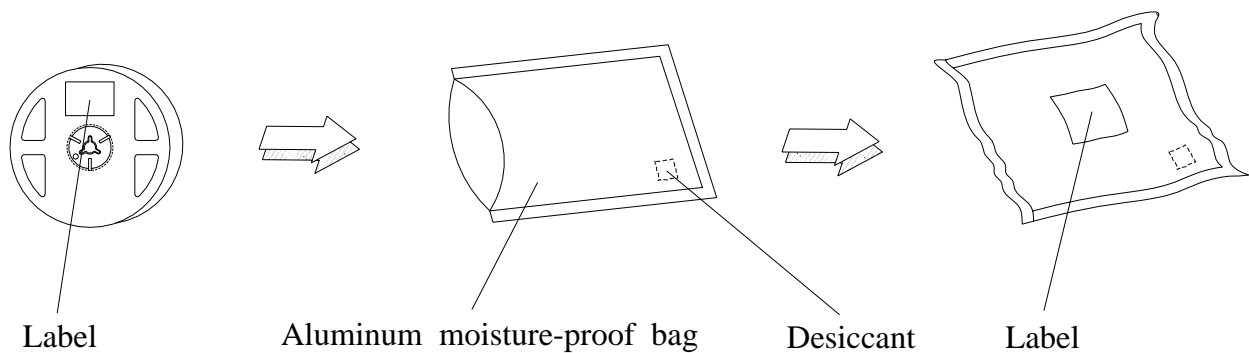

**Reliability Test Items And Conditions**

The reliability of products shall be satisfied with items listed below.

Confidence level : 90%

LTPD : 10%

No.	Items	Test Condition	Test Hours/Cycles	Sample Size	Ac/Re
1	Reflow Soldering	Temp. : 260°C ±5°C Min. 5sec.	6 Min.	22 PCS.	0/1
2	Temperature Cycle	H : +100°C 15min ∫ 5 min L : -40°C 15min	300 Cycles	22 PCS.	0/1
3	Thermal Shock	H : +100°C 5min ∫ 10 sec L : -10°C 5min	300 Cycles	22 PCS.	0/1
4	High Temperature Storage	Temp. : 100°C	1000 Hrs.	22 PCS.	0/1
5	Low Temperature Storage	Temp. : -40°C	1000 Hrs.	22 PCS.	0/1
6	DC Operating Life	IF = 20 mA	1000 Hrs.	22 PCS.	0/1
7	High Temperature / High Humidity	85°C / 85%RH	1000 Hrs.	22 PCS.	0/1

## Precautions For Use

### 1. Over-current-proof

Customer must apply resistors for protection, otherwise slight voltage shift will cause big current change ( Burn out will happen ).

### 2. Storage

2.1 Do not open moisture proof bag before the products are ready to use.

2.2 Before opening the package: The LEDs should be kept at 30°C or less and 90%RH or less.

2.3 After opening the package: The LED's floor life is 1 year under 30°C or less and 60% RH or less.

If unused LEDs remain, it should be stored in moisture proof packages.

2.4 If the moisture absorbent material (silica gel) has faded away or the LEDs have exceeded the storage time, baking treatment should be performed using the following conditions.

Baking treatment : 60±5°C for 24 hours.

### 3. Soldering Condition

#### 3.1 Pb-free solder temperature profile

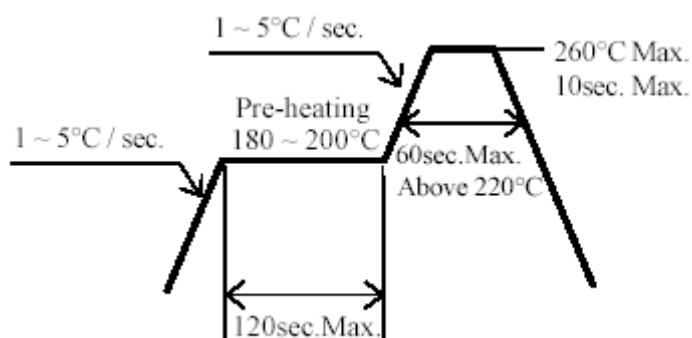

3.2 Reflow soldering should not be done more than two times.

3.3 When soldering, do not put stress on the LEDs during heating.

3.4 After soldering, do not warp the circuit board.

#### 4.Soldering Iron

Each terminal is to go to the tip of soldering iron temperature less than 350°C for 3 seconds within once in less than the soldering iron capacity 25W. Leave two seconds and more intervals, and do soldering of each terminal. Be careful because the damage of the product is often started at the time of the hand solder.

#### 5.Repairing

Repair should not be done after the LEDs have been soldered. When repairing is unavoidable, a double-head soldering iron should be used (as below figure). It should be confirmed beforehand whether the characteristics of the LEDs will or will not be damaged by repairing.

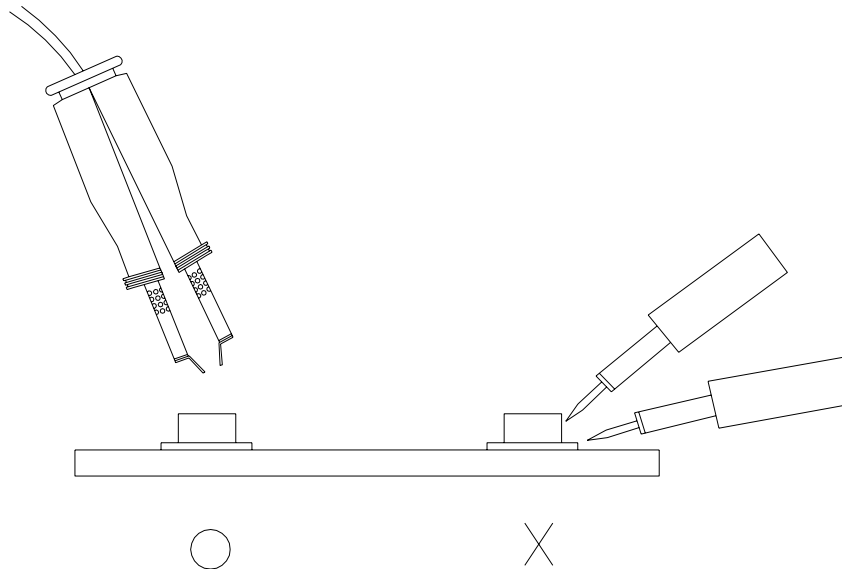

**EVERLIGHT ELECTRONICS CO., LTD.**

Office: No 25, Lane 76, Sec 3, Chung Yang Rd,  
Tucheng, Taipei 236, Taiwan, R.O.C

Tel: 886-2-2267-2000, 2267-9936

Fax: 886-2267-6244, 2267-6189, 2267-6306

<http://www.everlight.com>