

Q200neo

AC/DC Multi-Function Smart Charger

Instruction Manual

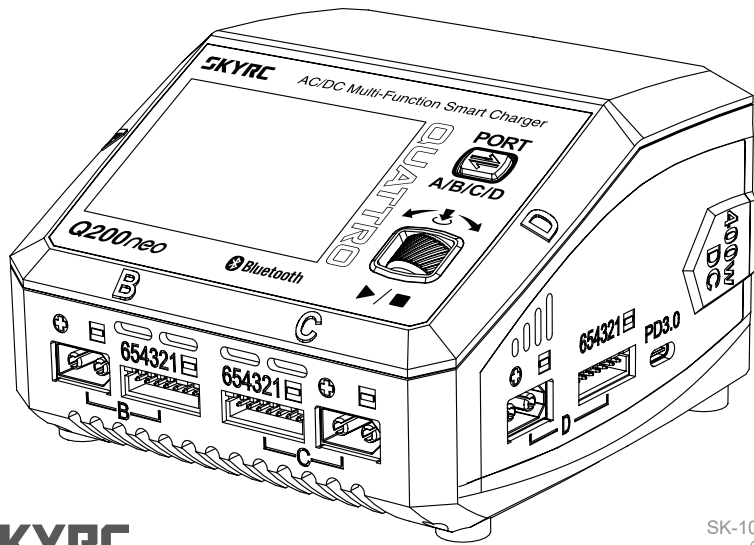

SKYRC

SK-100197

V1.0

Introduction	1
Package	1
Meet Q200neo	2
Specification	3
Warning	5
Standard Battery Parameters	6
Explanation of Buttons	7
Program Flow Chart	8
Power and Battery Connection	10
Charging	11
Lithium Battery Program(LiPo/LiFe/Lilon/LiHV)	13
NiMH/NiCd Battery Program	14
Pb Lead-Acid Battery Program	15
Charger Master	16
SkyCharger app Control	16
DC Power	17
USB Type-C PD/QC3.0 Output	18
Voltage Calibration (For expert user only)	19
Charge Settings	19
System Setting	20
Firmware Upgrade	21
Errors and Warnings	22
Conformity Declaration	23
Warranty and Service	24

Introduction

Introducing the SkyRC Q200neo AC/DC Multi-Function Smart Charger, an enhanced version of the Q200.

With four independent ports and compatibility with various RC batteries, it adapts to different chemistries. It can act as a quad-output digital power, offering adjustable voltage (1.0V-30V), and current (0.1A-10.0A) per output. The 20W USB-C PD 3.0 charging port allows rapid charging of smartphones, tablets, and the 2020 MacBook Air.

Connect effortlessly via Type-C or Bluetooth, and control it with Charger Master on PC, Mac, or smartphone.

Before using it for the first time, it is crucial to carefully read through the instructions, warnings, and safety tips provided. Improperly charging a battery or misusing the charger can lead to potentially hazardous situations such as fire or explosion.

Package



SkyRC Q200neo charger*1



User Manual*1

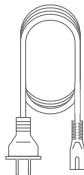

AC power Cord*1

Meet Q200neo

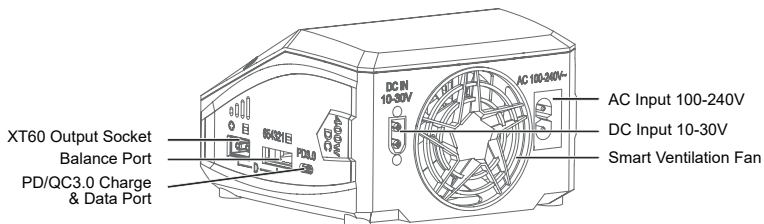
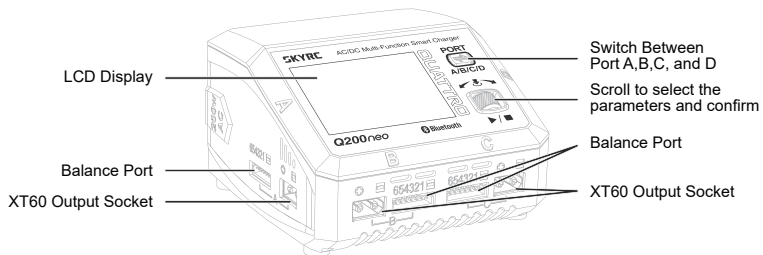

Specification

Item	Option	Specification
Model		Q200neo
Input Voltage	AC	100-240V (50/60Hz)
	DC	10.0-30.0V
Input Current	DC	30.0A
Charge Power	AC	Total 200W One Port: 100W Max Two Ports: 100W*2 Three Ports: 66W*3 Four Ports: 50W*4 PD3.0: 20W Max Power distribution priority: Type-C>A>B>C>D
	DC	Total 400W One Port: 100W Max Two Ports: 100W*2 Three Ports: 100W*3 Four Ports: 100W*4 PD3.0: 20W Max Power distribution priority: Type-C>A>B>C>D
Discharge Power	Main Port	5W
	Main Port+Balance Port	25W (LiPo/6S)
Charge Current	LiPo/LiFe/Lilon/LiHV/ NiMH/NiCd/Pb	0.1-10.0A
Discharge Current	LiPo/LiFe/Lilon/LiHV/ NiMH/NiCd/Pb	0.1-2.0A
Balance Current	LiPo/LiFe/Lilon/LiHV	800mA Max
Trickle Charge Current	NiMH/NiCd	50-300mA & OFF

Item	Option	Specification
Battery Types	LiPo/LiFe/Lilon/LiHV	1-6S
	NiMH/NiCd	2-15S
	Pb	3S/6S/12S
Working Modes	LiPo/LiFe/Lilon/LiHV	Balance CHG, Charge, Discharge, Storage
	NiMH/NiCd	Normal, Discharge, Re-Peak, CYCLE_D_C, CYCLE_C_D
	Pb	Charge, AGM Charge, Cold Charge, Discharge
DC Power Supply	Voltage	1.0-30.0V
	Current	0.1-10.0A
	Power	Max. 100W single port
USB Type-C Output	QC3.0	5V=3A, 9V=2A, 12V=1.5A 18W
	PD	5V=3A, 9V=2.2A, 12V=1.67A 20W
Size	Length*Width*Height	123*119*78mm
Weight	Net Weight	680g
Working Environment	Working Temperature	0°C-40°C
	Working Humidity	10%-80%
Storage Environment	Storage Temperature	-10°C-60°C
	Storage Humidity	20%-70%

Warning

Q200neo is not intended for use by persons with reduced physical, sensory or mental capabilities, or lack of experience and knowledge, unless they have been given supervision or instruction concerning the use of the charger by a person responsible for their safety.

Failure to exercise caution while using this product and comply with the following warnings could result in a product malfunction, electrical issues, excessive heat, FIRE, and ultimately injury and property damage.

- ⚠ Never leave charging batteries unattended during use.
- ⚠ Never charge batteries overnight.
- ⚠ Never attempt to charge dead, damaged, or wet battery packs.
- ⚠ Never attempt to charge a battery pack containing different types of batteries.
- ⚠ Never charge batteries in extremely hot or cold places or place in direct sunlight.
- ⚠ Never charge a battery if the cable has been pinched or shorted.
- ⚠ Never connect the charger if the power cord has been pinched or shorted.
- ⚠ Never attempt to dismantle the charger or use a damaged charger.
- ⚠ Never attach your charger to both an AC and a DC power source at the same time.
- ⚠ Always use the charger with the correct charging and discharging program.
- ⚠ Always use only rechargeable batteries designed for use with this type of charger.
- ⚠ Never use the charger on car seats, carpets, or similar surfaces.
- ⚠ Always operate the charger away from flammable and explosive materials.

Standard Battery Parameters

	LiPo	Lilon	LiFe	LiHV	NiMH	NiCd	Pb
Nominal voltage	3.7V/cell	3.6V/cell	3.3V/cell	3.8V/cell	1.2V/cell	1.2V/cell	2.0V/cell
Max. charge voltage	4.2V/cell	4.1V/cell	3.65V/cell	4.35V/cell	1.5V/cell	1.5V/cell	2.4V/cell
Storage voltage	3.8V/cell	3.7V/cell	3.3V/cell	3.85V/cell	N/A	N/A	N/A
Allowable fast charge current	≤ 1C	≤ 1C	≤ 4C	≤ 1C	1C-2C	1C-2C	≤ 0.4C
Min. discharge voltage	3.0-3.4V/ cell	2.9-3.3V/ cell	2.6-3.0V/ cell	3.1-3.5V/ cell	0.6-1.0V/ cell	0.6-1.0V/ cell	1.8-2.0V/ cell

Select the correct operating procedure in accordance with the battery parameters.

Incorrect settings may cause the battery to burn or even explode.

Explanation of Buttons

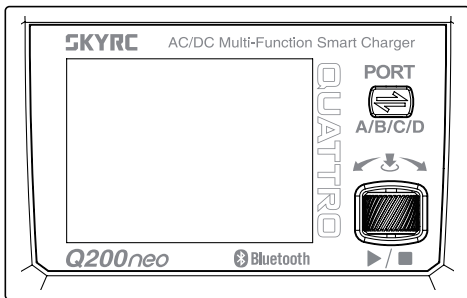

Port Switch Button

Switch Between Ports A,B,C,and D



Scroll Button

Navigate through Ports A,B,C,and D in the home menu

Short-press to enter into parameters setting and confirm your selection.

Scroll the wheel to select different menus or adjust parameters.

Press and hold the scroll wheel for two seconds to access the System Setting menu.

Program Flow Chart

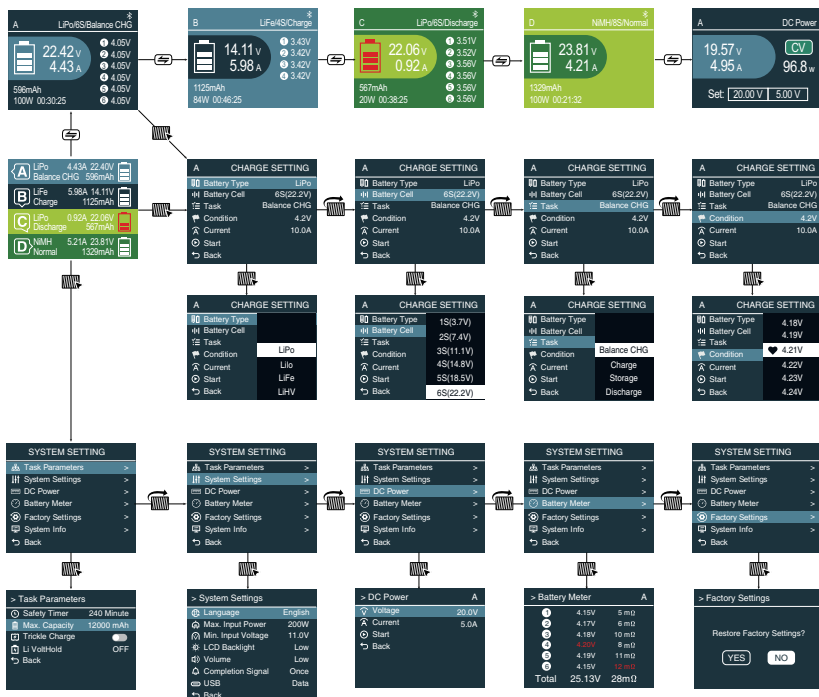

Note: This flow chart provides an example for one port, and the charts for the four ports (Ports A, B, C, and D) are identical



Power and Battery Connection

1. Connect to power source

There are two options of inputs for SkyRC Q200neo: AC 100-240V or DC 10-30V.

AC 100-240V

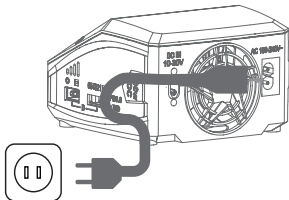

12V DC Battery

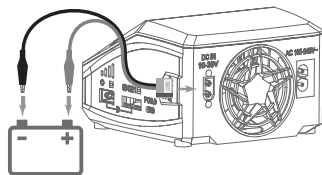

*12V DC Battery or
10-30V DC Power Supply

2. Connect the battery



WARNING!

TO AVOID SHORT CIRCUITS, ALWAYS CONNECT THE CHARGE LEADS TO THE CHARGER FIRST AND THEN TO THE BATTERY. REVERSE THE SEQUENCE WHEN DISCONNECTING.

1) LiPo Battery Connection with Balance Adapter

For safety reasons, it is highly recommended to charge Lithium batteries (LiPo, Lilon, LiFe and LiHV) using Balance CHG mode unless the battery comes without a balance connector.

The balance wire attached to the battery must be connected to the charger with the black wire aligned with the negative marking. Ensure correct polarity!

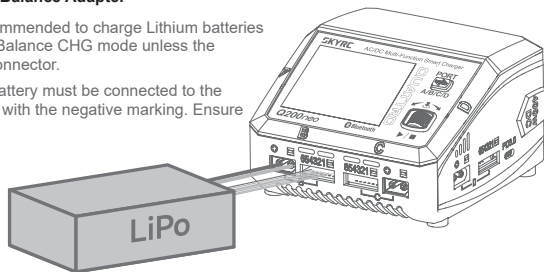

2) NiMH/NiCd or Pb Battery Connection

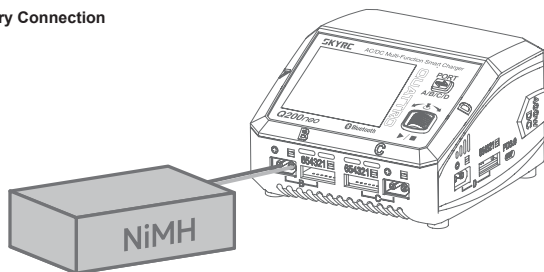

Charging

Various operations are applicable depending on the battery type. This chart illustrates which operations are relevant for different types of batteries.

Battery Type	Working Mode	Description
LiPo Lilon LiFe LiHV	Balance CHG	This mode is to balance charge the lithium battery based on the charging rate the user set. It can balance each cells of the battery.
	Charge	This mode is to charge the lithium battery based on the charging rate selected.
	Storage	This mode is to store the battery via charging or discharging its voltage to a specific storage value.
	Discharge	This mode is to discharge the lithium battery based on the discharging rate selected.

Battery Type	Working Mode	Description
NiMH NiCd	Charge	This mode is to charge the NiMH/NiCd battery based on the charging rate selected.
	Discharge	This mode is to discharge the NiMH/NiCd battery based on the discharging rate selected.
	Re-Peak	In re-peak charge mode, the charger can peak charge the battery twice in a row automatically. This is good for confirming the battery is fully charged.
	Cycle_D_C	1 to 3 cyclic and continuous process of discharge>charge is operable for refreshing and restoring the performance of NiMH/NiCd batteries.
	Cycle_C_D	1 to 3 cyclic and continuous process of charge>discharge is operable for refreshing and restoring the performance of NiMH/NiCd batteries.
Pb	Normal	This mode is to charge the Pb battery based on the charging rate selected.
	AGM Charge	This mode is to charge the AGM battery based on the charging rate selected.
	Cold Charge	This mode is to charge the Pb battery under a low temperature based on the charging rate selected.
	Discharge	This mode is to discharge the Pb battery based on the discharging rate selected.

Lithium Battery Program(LiPo/LiFe/Lilon/LiHV)

The following flowchart is a reference to set the program manually.

Scroll to select the port and short-press to confirm.

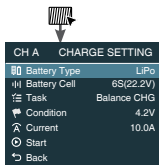

Enter CHARGE SETTING

Short-press the Scroll Wheel to enter the CHARGE SETTING.

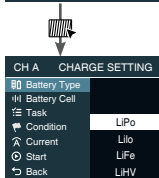

Select Battery Type

Short-press the Scroll Wheel to call out the Battery Type menu, and scroll to select LiPo.

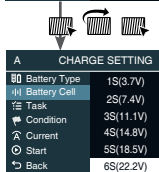

Select Battery Cell

Scroll to Battery Cell to call out the menu and scroll to select the correct battery cells.

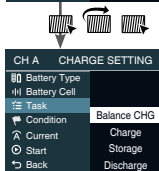

Select Task

Scroll to Task, call out the menu and scroll to select the working mode.

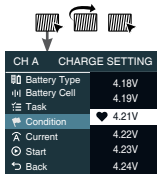

Select Condition

Scroll to Condition, call out the menu and select the terminal charging voltage.

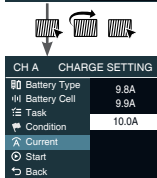

Set Charge/Discharge Current

Scroll to Charge/Discharge Current, call out the menu and scroll to select the current.

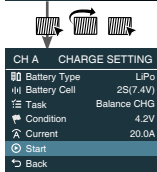

Start

Short-press the Scroll Wheel to confirm and initiate the program.



Stop

Short-press the Scroll Wheel to stop the program. If confirm to stop, short-press the Scroll Wheel again to confirm. If not stop, short-press the Port button to back.

NiMH/NiCd Battery Program

Scroll to select the port and short-press to confirm.

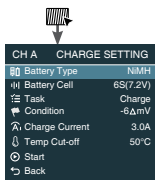

ENTER CHARGE SETTING

Short-press the Scroll Wheel to enter the CHARGE SETTING.

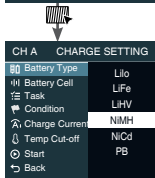

Select Battery Type

Short-press the Scroll Wheel to call out the Battery Type menu, and scroll to select NiMH.

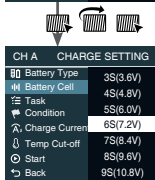

Select Battery Cell

Scroll to Battery Cell, call out the menu and scroll to select the correct battery cells.

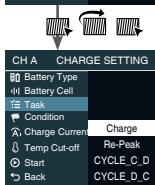

Select Task

Scroll to Task, call out the menu and scroll to select the working mode.

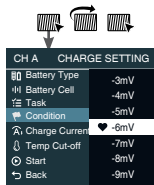

Select Condition

Scroll to Condition, call out the menu and set the delta voltage.

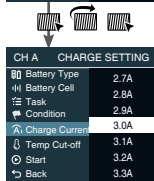

Set Charge/Discharge Current

Scroll to Charge/Discharge Current, call out the menu and scroll to select the current

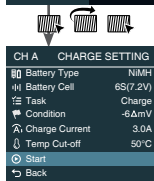

Start

Short-press the Scroll Wheel to confirm and initiate the program.

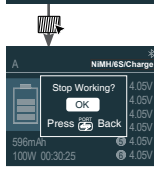

Stop

Short-press the Scroll Wheel to stop the program. If prompted to stop, short-press the Scroll Wheel again to confirm, or short-press the Port button to return.

Pb Lead-Acid Battery Program

Scroll to select the port and short-press to confirm.

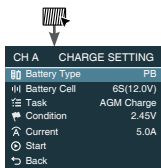

ENTER CHARGE SETTING

On the main interface, press the Scroll Wheel to enter CHARGE SETTING.

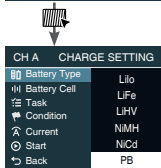

Select Battery Type

Short-press the Scroll Wheel to call out the Battery Type menu, and scroll to select Pb.

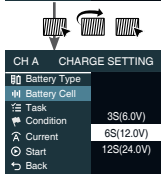

Select Battery Cell

Scroll to Battery Cell, call out the menu and scroll to select the correct battery cells.

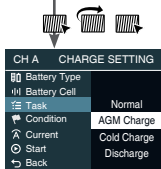

Task Select

Scroll to Task, call out the menu and scroll to select the working mode.

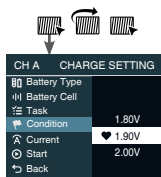

Select Condition

Scroll to Condition, call out the menu and set the delta voltage.

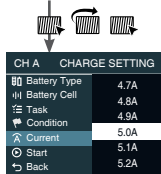

Set Charge/Discharge Current

Scroll to Charge/Discharge Current, call out the menu and scroll to select the current.

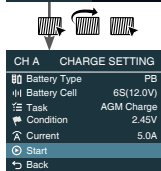

Start

Short-press the Scroll Wheel to confirm and initiate the program.



Stop

Short-press the Scroll Wheel to stop the program. If prompted to stop, short-press the Scroll Wheel again to confirm, or short-press the Port button to return.

Charger Master

The Q200neo offers the convenience of charging and discharging directly from your computer, whether you're using Windows or MacOS. It provides a visual display of various parameters, such as charge time, capacity, charge current, and voltage, presented in a curve format.

1. Download the latest Charger Master onto your desktop. Unzip and open it;
2. Choose Data for USB work mode in System Setting>USB;
3. Connect Q200neo to your computer via a USB type-C cable;

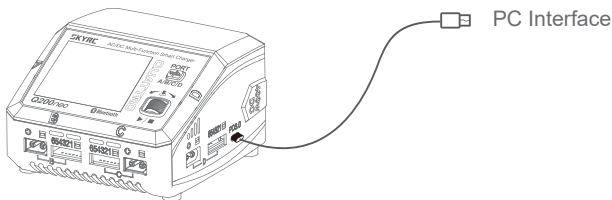

4. On the top left panel, choose the expected work mode to initiate the program.

SkyCharger app Control

With the built-in Bluetooth 5.0, Users can easily control the Q200neo charger through the SkyCharger app. The firmware can be upgraded over the OTA(On the Air).

Scan the QR code below to download the SkyCharger app!



SkyCharger



DC Power

On the main menu, hold the Scroll Wheel for two seconds to enter Charger Setting>DC Power. Select the options of DC Power: adjust the output voltage and current. Select Start to activate the DC Power working mode.

When acting as a digital power supply, Q200neo can regulate its output voltage or output current at a constant level. Constant Current(CC) Mode and Constant Voltage(CV) Mode can switch automatically as follows:

If $R \text{ load} > (V \text{ out} / I \text{ out})$ then power supply is in CV mode

If $R \text{ load} < (V \text{ out} / I \text{ out})$ then power supply is in CC mode

This is essential and vital for efficient and precise power delivery in various applications for our RC professionals!

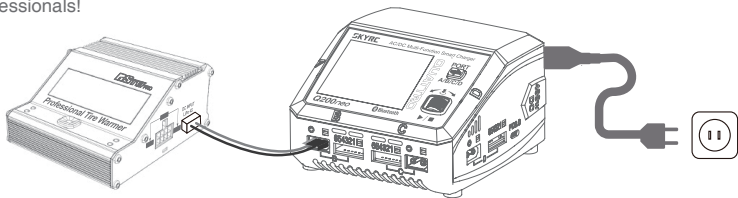

*Benefits of using a CC/CV mode DC power supply explained:

- 1. Versatility:** CC/CV power supplies are versatile because they can switch between constant current and constant voltage modes. This makes them suitable for a wide range of applications, from powering delicate electronics to driving high-power devices.
- 2. Protection:** The CC mode can prevent overcurrent situations, which could damage electronic devices or create hazardous situations. By setting a maximum current limit, the power supply ensures that it won't deliver more current than the device can safely handle.
- 3. Battery Charging:** CC/CV power supplies are particularly useful for charging lithium-ion batteries, which require a precise charging protocol. Initially, the charger works in CC mode to restore most of

the battery's capacity, then switches to CV mode to top off the charge while preventing overcharging.

- 4. Optimized for Various Loads:** Some loads require a specific voltage to operate correctly, while others need a particular current. A CC/CV power supply can adapt to these needs, providing a stable and suitable power output under various load conditions.
- 5. Improved Efficiency:** By dynamically switching between modes depending on the load, a CC/CV power supply can often operate more efficiently than a power supply using only one mode.
- 6. Safe for LED Driving:** LEDs are current-driven devices, and a slight increase in voltage can lead to a high current, causing damage to LEDs. CC mode allows safe driving of LEDs. CV mode can be useful when LEDs are configured in parallel strings.

USB Type-C PD/QC3.0 Output

With the 20W USB-C PD 3.0 charging port, our RC players can enjoy rapid charging speeds like never before. Whether you're charging your smartphones, tablets, or 2020 MacBook Airs, this powerful port ensures that you can fuel up your devices in a fraction of the time.

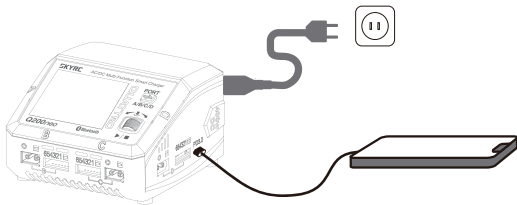







Voltage Calibration (For expert user only)

You can calibrate the voltage directly on the charger with a 6S LiPo battery. For more information, please contact us at info@SkyRC.com















Charge Settings









On the main interface, press the Scroll Wheel to enter Charge Setting: switch between ports A,B,C and D by pressing the Port button, or set parameters as below:

Menu	Definition
 Battery Type	Select the desired battery type. (LiPo, Lilon, LiFe, LiHV, Pb, NiMH, NiCd)
 Battery Cell	Select the number of battery cells by different battery type. (Li-xx: 1-6S, Ni-xx: 2-15S, Pb: 3S/6S/12S)
 Task	Select the work mode to be performed. (Balance CHG, Charge, Storage, Discharge, etc.)
 Condition	Set the cut-off voltage.
 Current	Set the charge or discharge current.
 Start	Start the program.
 Back	Back to the main interface.

System Setting

On the main interface, hold the Start button for two seconds to enter the System Setting.

Menu	Option	Definition
 Task parameters	 Safety Timer	Customize a period for program protection.
	 Max.Capacity	Customize the protection of capacity.
	 Trickle Charge	Enable/disable trickle charge.
	 Li Volt Hold	Enable/disable Li Volt Hold If the difference great than 0.02V between each cells detected, a small current will be applied to keep the battery voltage.
	 Back	Back to the previous interface.
 System Settings	 Language	Select the desired language.
	 Max.Input Power	The maximum charge power. AC Input: 200W DC Input: 400W
	 Min.Input Voltage	Set the minimum voltage for input protection.
	 LCD Backlight	Adjust the brightness of the screen.
	 Volume	Adjust/Turn off the volume of the key and beep.
	 Completion Signal	Choose the way you'd like to be reminded when the program completes. If Repeat is chosen, the charger will play the completion signal every half an hour.
	 USB	Select the mode of the USB Type-C port: Auto: the charger detects the input of the USB port automatically; Data: connect for communication; Charge: charge the digital devices;
	 Back	Back to the previous interface.

Menu	Option	Definition
 DC Power (Press the Port button to switch between port A,B,C,and D)	 Voltage	Set the output voltage. (1.0-30.0V)
	 Current	Set the output current. (0.1-10.0A)
	 Start	Enable DC power output and return to the main interface.
	 Back	Back to the previous interface.
 Battery Meter	N/A	Measure the battery voltage and internal resistance. (switch between ports A,B,C,and D ports by pressing the Port button.)
 Factory Settings	N/A	Restore to the factory settings.
 System Info	N/A	Check the current system status.
 Back	N/A	Back to the previous interface.

Firmware Upgrade

To recover from a firmware upgrade failure, please follow these steps:

1. Press and hold the Scroll Wheel, then connect the power cord; Q200neo will power on with a blue screen notice.
2. Connect Q200neo to your computer via a Type-C USB cable;
3. Launch the Charger Master on your computer;
4. When the status shows CONNECTED, click to check for new firmware;
5. Click to upgrade after detecting a new firmware;
6. Wait for the progress bar to finish and reach 100%; The process takes about 5 minutes.

Errors and Warnings

In the event of a fault, the charger will display an error message and sound an alarm.

Error Message	Explanation
Error: DC Input Low!	DC input voltage is lower than preset!
Error: DC Input High!	DC input voltage is higher than preset!
Error: Battery Error!	The battery is broken or not detected!
Error: Connection Break!	The battery connection is broken!
Cell Error	The cells do not match.
Battery Type Error!	The battery type is wrong!
Error: Overcharge!	The battery is overcharged!
Error: Over Time!	The program is timed out!
Error: Internal Temp. Too High!	The internal temperature is high!
Error: Over Load!	The charger is overloaded!
Error: Reversed Polarity	The battery connection is reversed.
Error: Fully Charged	The battery is fully charged already!
Error: Outlet Overload	The output is overloaded.
Error: Balance Connection Break	The balance connection disconnects.
Error: Cell Volt Diff.	The voltage difference between each cell is high.
Error: AC to DC Too Low!	The input voltage is too low.
Error: Power Setting Error	The DC power setting is incorrect.

Conformity Declaration

SkyRC Q200neo satisfies all relevant and mandatory CE directives and FCC Part 15 Subpart B.

Test Standards	Title	Result
EN 60335-1	Household and similar electrical appliances - Safety -Part 1: General requirements	Conform
EN 60335-2-29	Household and similar electrical appliances – Safety – Part2-29: Particular requirements for battery chargers.	Conform
EN 55014-1	Electromagnetic compatibility – Requirements for household appliances, electric tools and similar apparatus - Part 1:Emission	Conform
EN 55014-2	Electromagnetic compatibility – Requirements for household appliances, electric tools and similar apparatus – Part 2: Immunity Product Family Standard	Conform
EN 61000-3-2	Electromagnetic compatibility (EMC) – Part 3-2: – Limits for harmonic current emissions (equipment input current up to and including 16 A per phase)	Conform
EN 61000-3-3	Electromagnetic compatibility (EMC) - Part 3-3: Limitation of voltage supply systems for equipment with rated current ≤ 16 A.	Conform
FCC Part Subpart 15B	Title 47 Telecommunication PART 15 - RADIO FREQUENCY DEVICES Subpart B - Unintentional Radiators	Conform
EN 300328	Electromagnetic compatibility and Radio spectrum Matters (ERM); Wideband transmission systems; Data transmission equipment operating in the 2.4 GHz ISM band and using wide band modulation techniques; Harmonized EN covering essential requirements under article 3.2 of the R&TTE Directive.	Conform
EN 301489-1EN 301489-17	Electromagnetic compatibility and Radio spectrum Matters (ERM); ElectroMagnetic Compatibility (EMC) standard for radio equipment and services; Part 1: Common technical requirements. Part 17: Specific	Conform
EN 50663: 2017	Generic standard for assessment of low power electronic and electrical equipment related to human exposure restrictions for electromagnetic fields (10 MHz - 300 GHz)	Conform
EN 62479	Assessment of the compliance of low power electronic and electrical equipment with the basic restrictions related to human exposure to electromagnetic fields (10 MHz to 300 GHz)	Conform
EN 61558-2-16 EN 61558-1	Safety of transformers, reactors, power supply units and similar products for supply voltages up to 1 100 V - Part 2-16: Particular requirements and tests for switch mode power supply units and transformers for switch mode power supply units	Conform
Part 15 Section 15.247	Operation within the bands 902 - 928 MHz, 2400 - 2483.5 MHz, and 5725 - 5850 MHz.	Conform

Warranty and Service

Liability Exclusion

This charger is designed and approved exclusively for use with the types of battery stated in this Instruction Manual. SkyRC accepts no liability of any kind if the charger is used for any purpose other than that stated. We are unable to ensure that you follow the instructions supplied with the charger, and we have no control over the methods you employ for using, operating, and maintaining the device. For this reason, we are obliged to deny all liability for loss, damage, or costs that are incurred due to the incompetent or incorrect use and operation of our products, or which are connected with such operation in any way. Unless otherwise prescribed by law, our obligation to pay compensation, regardless of the legal argument employed, is limited to the invoice value of those SkyRC products which were immediately and directly involved in the event in which the damage occurred.

Warranty and Service

We guarantee this product to be free of manufacturing and assembly defects for a period of one year from the time of purchase. The warranty only applies to material or operational defects, which are present at the time of purchase. During that period, we

will repair or replace free of service charge for products deemed defective due to those causes.

This warranty is not valid for any damage or subsequent damage arising as a result of misuse, modification, or as a result of failure to observe the procedures outlined in this manual.

Note:

The warranty service is valid in China only.

If you need warranty service overseas, please contact your dealer in the first instance, who is responsible for processing guarantee claims overseas. Due to high shipping costs, and complicated custom clearance procedures to send back to China, please understand that SkyRC can't provide warranty service to overseas end users directly.

If you have any questions which are not mentioned in the manual, please feel free to send an email to info@skyrc.com

SKYRC

The manual is subject to change without notice;
please refer to our website for the latest version!

Manufactured by
SKYRC TECHNOLOGY CO., LTD.
www.skyrc.com

© 2023 SkyRC Trchnology Co., Ltd. All Rights Reserved



[Version 1.0]