

A2 mini

ULTRA WIDE ANGLE FPV GIMBAL USER MANUAL



V1.1

June 2023

Thank you for purchasing SIYI product.

A2 mini is a lightweight and ultra-wide-angle FPV gimbal, built with industrial protection class, the 160-degree horizontal FOV makes camera view wide and broad. Pitch angle control can be widely used for agriculture spraying drones. Ethernet output can be used with some third-party links. Upside-down mode makes it also a great option for UGV, USV, robotics, RC hobby planes.

To ensure you a good experience of the product, please read this manual carefully. If you encounter any issue using the product, please consult the manual or check the online pages of this product on SIYI official store (<https://shop.siyi.biz>). You can also write an email to SIYI official A/S center (support@siyi.biz).

SIYI User Group - Facebook



SIYI Official Store (<https://shop.siyi.biz>)

SIYI Official AliExpress Store (<https://siyi.aliexpress.com>)

SIYI YouTube Channel (<https://www.youtube.com/c/SIYITech>)

CONTENT

READ TIPS	1
Icons	1
Safety	1
Storage/Carrying/Recycling	2
1 INTRODUCTION	3
1.1 Product Features	3
1.2 Parts	5
1.2.1 At a Glance	5
1.2.2 Connector and Pinouts	6
1.3 Technical Specification	7
1.4 Packing List	8
2 GET READY TO USE A2 MINI	9
2.1 Installation	9
3 GIMBAL CONTROL	10
3.1 Control through SIYI FPV App or SIYI QGC App on SIYI Handheld Ground Station	10
3.1.1 Preparation	10
3.1.2 Gimbal Pitch Rotation	12
3.2 Control through PWM / S.Bus Signal (Taking an Example of MK15)	12
3.2.1 Preparation	12
3.3 Ethernet SDK Protocol Control	16
3.3.1 SDK Protocol Format	16
3.3.2 SDK Communication Commands	16
3.3.3 SDK Communication Interface	26
3.3.4 SIYI Gimbal Camera SDK Communication Code Examples	26
3.3.5 SDK CRC16 Code	28
3.3.6 Advanced Guide for SIYI Gimbal SDK Integration	30
3.4 Control in SIYI QGC Windows Software through HM30 Image Transmission System	33
3.4.1 Preparation	34
3.4.2 Gimbal Pitch Rotation	36
4 VIDEO OUTPUT	36
4.1 Output and Display Video Stream on SIYI Ground Station	37

4.2 Output Video Stream to Android Device through HM30 Full HD Image Transmission System	37
4.3 Output Video Stream to Windows Device through HM30 Full HD Image Transmission System	39
4.4 Output to Third-Party Links	39
4.5 Solutions to No Image	40
4.5.1 Video Output to Android Device	41
4.5.2 Video Output to Windows Device	42
4.6 Common IP Addresses	44
5 SIYI FPV APP	45
5.1 Settings	47
5.2 Link Status	48
5.3 Gimbal Camera	49
5.4 About SIYI FPV	52
6 After-sale Service	53
6.1 Repair Service	53
6.2 Warranty	54
6.2.1 7-Day Return & Refund	54
6.2.2 15-Day Replacement	55
6.2.3 1-Year Warranty Repair	57

READ TIPS

Icons

Please pay more attention to content indicated with the following marks:

 **DANGER** Dangerous manipulation probably leads to human injuries.

 **WARNING** Warnings on manipulation possibly leads to human injuries.

 **CAUTION** Cautions on what manipulation may lead to property loss.

 **Prohibited**  **Mandatory**  **Mark**

Safety

A2 mini FPV gimbal is designed for professional application in specific scenes, which has been done necessary configuration before delivery, it is forbidden to disassemble the gimbal or to change its mechanical structure. And don't add more payload to the gimbal other than its own camera. Gimbal camera is designed with very precise structure, users who approach to the equipment should have the basic knowledge of how to operate it. Irregular or irresponsible manipulations to the device may cause damage, property loss, or human injuries, and SIYI Technology is not obliged to any of the damage, loss, or injury. It is prohibited to use SIYI products for military purpose. Users under 14 years' old should follow an

experienced trainer's guide. Disassembling or modification to the system is prohibited without permission from its manufacturer, SIYI Technology.

Storage/Carrying/Recycling

When your SIYI products are stand idle, or you are bringing it outdoors, or the system reached service life, then please do read the precautions below.



CAUTION

Always place your SIYI products at places where babies or kids do not reach.



DANGER

SIYI products should be placed in places with below conditions:

Not too hot (above 60°C) or too cold (under -20°C).

Not under direct sunshine or too dusty or too wet.

Not on an unstable holder which lacks solid supports or may cause vibration.

Not nearby steam or other heat sources.

1 INTRODUCTION

1.1 Product Features

Ultra-Wide Angle FOV, Distortion Correction

A2 mini comes with a horizontal 160-degree ultra-wide-angle lens, providing an extensive view of the operation field that operator has clear sight during flight without adjusting drone attitude too much. Quick decisions can be made to ensure security to drone operation.

Powerful distortion correction algorithm makes A2 mini's image smooth and natural.

**SIYI FPV app is suggested for checking FPV image and SDK is available for developers and manufacturers.*

1080P Full HD Starlight FPV

A2 mini FPV gimbal's ultra-sensitive starlight CMOS can keep image bright even in low light environment.

Upside Down Mode

A2 mini FPV gimbal automatically activates upside down mode when it is placed upside down, very convenient to be mounted on multiple kinds of vehicles like UGV, USV, robot dog, and robotics.

Gimbal Stabilizing Control Algorithms

A2 mini FPV gimbal is applied with industry-level stabilizing technology and high-precision FOC control algorithms. Operator can control the tilt angle.

1.2 Parts

1.2.1 At a Glance



1.2.2 Connector and Pinouts

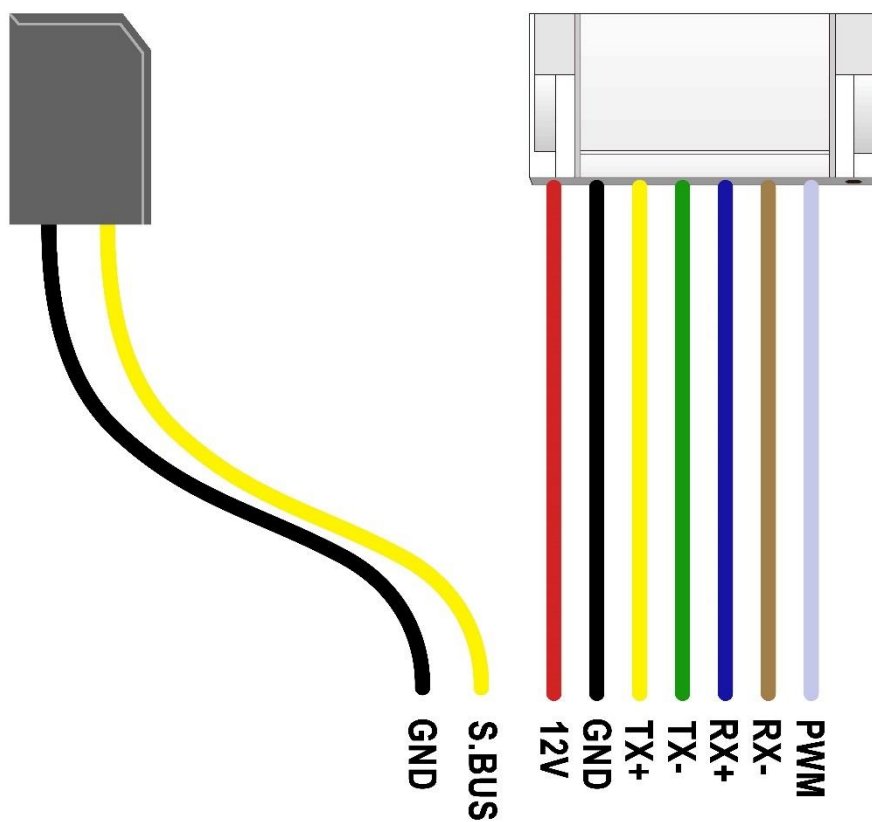

1.3 Technical Specification

Overall

Video Output Port	Ethernet
Control Signal Input Port	S.Bus, PWM, Ethernet UDP
Working Voltage	12 V
Power Consumption	Average 2 W Summit 12 W
Working Temperature	-10 ~ 50 °C
Dimension	65*43*50 mm
Weight	85 g

Gimbal

Controllable Pitch Angle	-90° ~ 25°
---------------------------------	------------

Camera

FOV	Horizontal 160°
Image Sensor	1/2.7-inch, 2 MP effective resolution

1.4 Packing List

1 x A2 mini FPV Gimbal

1 x A8 mini Screw Pack

(Using with the fixing board to mount the gimbal, including 6 x Hex Socket Cap Screw M2.5*5, 10 x Cross Recessed Flat Head Screw M2.5*10, 8 x M2.5 Nut Black)

1 x A8 mini Mounting Board & Damper Pack

(For mounting and fixing gimbal and stabilization)

2 GET READY TO USE A2 MINI

2.1 Installation

Screw Holes' Position and Distance

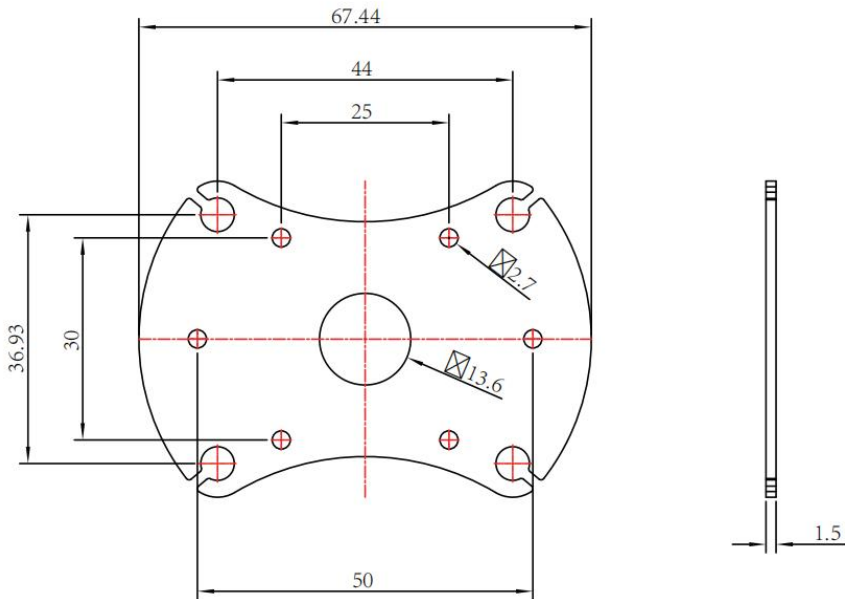

Mark

The specs of the screws for fixing the four tube screws are M.25*8 mm. Quantity: 4.

Welcome to contact SIYI to get the SIYI Gimbal 3D Model for pre-installation.

3 GIMBAL CONTROL

A2 mini gimbal can be controlled in multiple ways.

3.1 Control through SIYI FPV App or SIYI QGC App on SIYI Handheld Ground Station

Gimbal connects to air unit directly to control gimbal rotation, gimbal functions, and video display in SIYI FPV app or SIYI QGC app when the air unit is communicating with the ground station.

3.1.1 Preparation

It is necessary to prepare the tools, firmware, and software below before controlling gimbal camera in this way.

- SIYI Handheld Ground Station (MK32 Standard Combo / MK15 Enterprise Standard Combo is suggested for excellent compatibility with SIYI gimbal cameras)
- A2 mini FPV Gimbal

Mark

Above products can be purchased from SIYI directly or from SIYI authorized dealers.

- SIYI FPV App (v2.5.12.572 or latest version)
- SIYI QGC App

Mark

Above software can be downloaded from relevant product page on SIYI official website.

SIYI FPV App Steps

1. Power air unit and bind it with ground station.
2. Connect the air unit's Ethernet port to the gimbal.
3. Update SIYI FPV app to the latest.
4. Run SIYI FPV app, go to "Settings" and select the relevant SIYI camera type with main / sub stream, video stream will display. Gimbal motion and camera functions can be controlled by ground station touchscreen.

SIYI QGC App Steps

1. Power air unit and bind it with ground station.
2. Connect the air unit's Ethernet port to the gimbal.
3. Run SIYI QGC app, go to "Comm Links – Video Settings", and select "RTSP Video Stream" for "Source", then enter the default RTSP addresses of SIYI gimbal camera, video stream will display. Gimbal motion and camera functions can be controlled by ground station touchscreen.

3.1.2 Gimbal Pitch Rotation

While SIYI FPV App or SIYI QGC app is running,

Sliding on touchscreen can control gimbal rotation. Sliding up and down is gimbal pitch rotation.

Double tap touchscreen, gimbal will automatically center.

Mark

Slide on touchscreen and hold it, gimbal will continue rotating till it reaches physical limit.

Farther that you hold it from the center of the screen, faster the gimbal rotates.

3.2 Control through PWM / S.Bus Signal (Taking an Example of MK15)

PWM signal is already connected when A2 mini gimbal is connected to air unit Ethernet port. S.Bus signal is an optional connection to air unit S.Bus port. Both ways are for gimbal control through joysticks / dials / switches / buttons on MK15 remote controller when it is communicating to the air unit.

3.2.1 Preparation

It is necessary to prepare the below tools, firmware, and software before

controlling gimbal camera in this way.

- MK15 Mini HD Smart Controller (MK15 Agriculture x A2 Mini FPV Combo or MK15 Enterprise Standard Combo is suggested for excellent compatibility with SIYI gimbals)
- A2 mini FPV Gimbal

Mark

Above products can be purchased from SIYI directly or from SIYI authorized dealers.

- SIYI TX App (v1.1.235 or latest version)

Mark

Above app can be downloaded from relevant product page on SIYI official website.

Steps for PWM Control

1. Power the air unit and bind it with the remote controller.
2. Connect A2 mini gimbal to the air unit's Ethernet port.
3. Run SIYI TX app on the remote controller.
4. Go to "System Settings – Channel 15" and switch the control of channel 15 to the gimbal for pitch control of A2 mini gimbal.

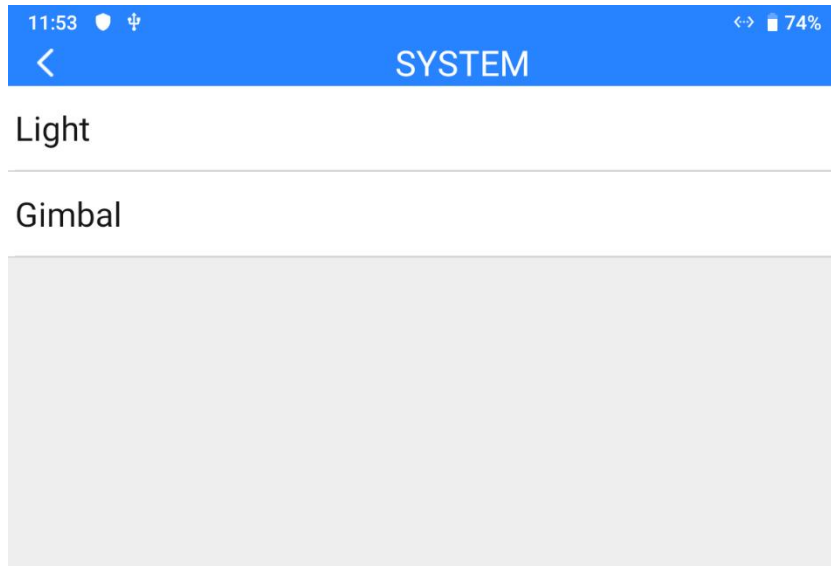

5. Go to “Channel Settings” and assign a joystick, a dial, a switch, or a button to channel 15.

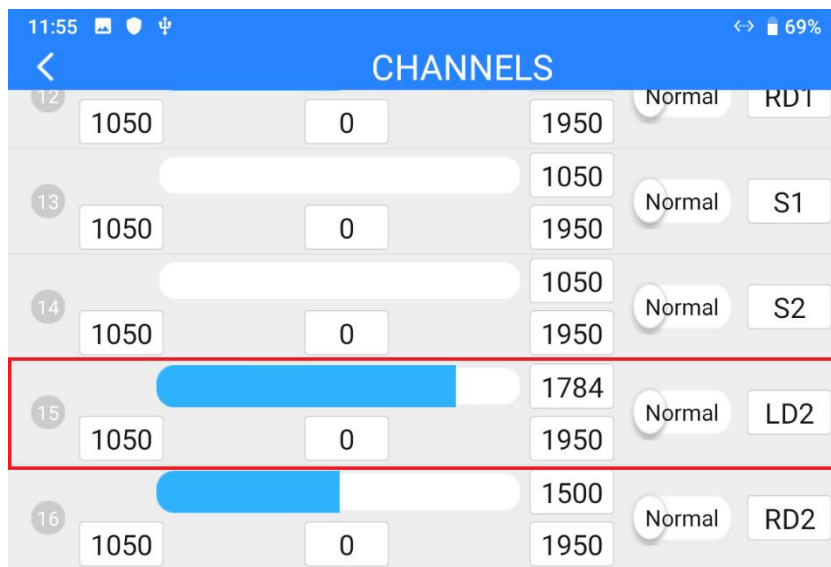

6. For the assigned channel, operate the relevant joystick, dial, switch, or button to confirm if it is working normally.

Steps for SBUS Control

1. Power the air unit and bind it with the remote controller.
2. Connect A2 mini gimbal to the air unit’s Ethernet port.

3. Run SIYI TX app on the remote controller.
4. Go to “Channel Settings” and assign a joystick, a dial, a switch, or a button to channel 15.

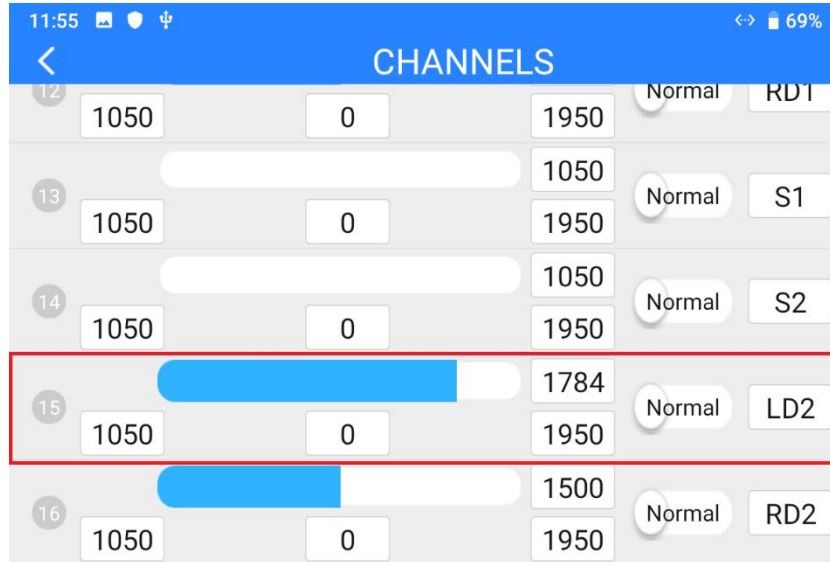

5. For the assigned channel, operate the relevant joystick, dial, switch, or button to confirm if it is working normally.

3.3 Ethernet SDK Protocol Control

SIYI gimbal camera provides control protocol for all customers. Please refer to the below guide for secondary development based on SIYI gimbal camera.

3.3.1 SDK Protocol Format

Field	Index	Bytes	Description
STX	0	2	0x6655: starting mark Low byte in the front
CTRL	2	1	0: need_ack (if the current data pack need “ack”) 1: ack_pack (if the current data pack is an “ack” package) 2-7: reserved
Data_len	3	2	Date field byte length Low byte in the front
SEQ	5	2	Frame sequence (0 ~ 65535) Low byte in the front
CMD_ID	7	1	Command ID
DATA	8	Data_len	Data
CRC16		2	CRC16 check to the complete data package. Low byte in the front

3.3.2 SDK Communication Commands

Acquire Firmware Version

CMD_ID:0x01-----Acquire Firmware Version			
Send data format			
No.	Data Type	Data Name	Description
ACK data format			
	uint32_t	code_board_ver	Camera firmware version
	uint32_t	gimbal_firmware_ver	Gimbal firmware version
	uint32_t	zoom_firmware_ver	Zoom firmware version

Eg: 0x6E030203 --> firmware version v3.2.3

Mark:

1. Ignore the 4th byte (higher byte)
2. Zoom firmware version is only available for ZR10 and ZR30 at this moment.

Acquire Hardware ID

CMD_ID:0x02----- Hardware ID			
Send data format			
No.	Data Type	Data Name	Description
ACK data format			
	Uint8_t	hardware_id[12]	Hardware ID character string (10 digits)

Auto Focus

CMD_ID:0x04-----Auto Focus			
Send data format			
No.	Data Type	Data Name	Description
1	uint8_t	auto_focus	1: Start auto focus for once
ACK data format			
1	uint8_t	sta	1: Success 0: Fail

Mark:

Auto focus command is only available for optical zoom gimbal cameras like ZT30, ZR30, and ZR10 at this moment.

Manual Zoom and Auto Focus

CMD_ID:0x05-----Manual Zoom and Auto Focus			
Send data format			
No.	Data Type	Data Name	Data Description
1	int8_t	zoom	1: Start zooming in 0: Stop zooming in / out (send when released from control command) -1: Start zooming out
ACK data format			
	uint16_t	zoom_multiple	Current (hybrid) zoom multiples, (zoom_multiple / 10, accurate to one

			decimal point)
--	--	--	----------------

Mark:

1. Auto focus command is only available for optical zoom gimbal cameras like ZT30, ZR30, and ZR10 at this moment.
2. Under this command, A8 mini can only do manual zoom and cannot do auto focus.

Absolute Zoom and Auto Focus

CMD_ID:0x0F-----Absolute Zoom and Auto Focus			
Send data format			
No.	Data Type	Data Name	Data Description
1	uint8_t	Absolute_movemen t_int	Input the integer part of the target multiple (0X1 ~ 0X1E)
2	uint8_t	Absolute_movemen t_float	Input the fractional part of the target multiple (0X0 ~ 0X9)
ACK data format			
	uint8_t	Absolute_movemen t_ask	Success and return to 1

Mark:

1. Absolute zoom command is only available for optical zoom gimbal cameras like ZT30, ZR30, and ZR10 at this moment.
2. Under this command, A8 mini can only do absolute zoom and cannot do auto focus.

Acquire the Max Zoom Value

CMD_ID:0x16-----Acquire the Max Zoom Value			
Send data format			
No.	Data Type	Data Name	Description
ACK data format			
	uint8_t	zoom_max_int	Integer of the max zoom value
	uint8_t	zoom_max_float	Float of the max zoom value

Mark:

This command is available only for models which can zoom.

Manual Focus

CMD_ID:0x06-----Manual Focus			
Send data format			
No.	Data Type	Data Name	Description

1	int8_t	focus	1: Long shot 0: Stop manual focus (send when released from control command) -1: Close shot
ACK data format			
	uint8_t	sta	1: Success 0: Fail

Mark:

Auto focus command is only available for optical zoom gimbal cameras like ZT30, ZR30, and ZR10 at this moment.

Gimbal Rotation

CMD_ID:0x07-----Gimbal Rotation			
Send data format			
No.	Date Type	Date Name	Description
1	int8_t	turn_yaw	-100~0~100: Negative and positive represent two directions, higher or lower the number is away from 0, faster the rotation speed is. Send 0 when released from control command and gimbal stops rotation.
2	int8_t	turn_pitch	-100~0~100: Same as above
ACK data format			
	uint8_t	sta	1: Success 0: Fail

Mark:

Under this command A2 mini can only control pitch rotation.

Center

CMD_ID:0x08-----Center			
Send data format			
No.	Data Type	Data Name	Description
1	uint8_t	center_pos	1: gimbal centers to position 0
ACK data format			
1	uint8_t	sta	1: Success 0: Fail

Acquire Gimbal Configuration Information

CMD_ID:0x0A-----Acquire Gimbal Configuration Information			
Send data format			
No.	Data Type	Data Name	Description
ACK data format			
1	uint8_t	reserved	
2	uint8_t	hdr_sta	0: HDR OFF 1: HDR ON
3	uint8_t	reserved	
4	uint8_t	record_sta	0: Recording OFF 1: Recording ON 2: TF card slot is empty 3: (Recording) Data loss in TF card recorded video, please check TF card
5	uint8_t	gimbal_motion_mode	0: Lock Mode 1: Follow Mode 2: FPV Mode
6	uint8_t	gimbal_mounting_dir	Gimbal Mounting Method 0: Reserved 1: Normal 2: Upside Down
7	uint8_t	video_hdmi_or_cvbs	(Only available on A8 mini) Video output status of HDMI and CVBS: 0: HDMI output ON CVBS output OFF 1: HDMI output OFF CVBS output ON

Mark:

Under this command A2 mini can only acquire "Gimbal Mounting Method".

Function Feedback Information

CMD_ID:0x0B-----Function Feedback Information			
Send data format			
No.	Data Type	Data Name	Description
ACK data format			

1	uint8_t	info_type	0: Success 1: Fail to take a photo (Please check if TF card is inserted) 2: HDR ON 3: HDR OFF 4: Fail to record a video (Please check if TF card is inserted)
---	---------	-----------	---

Mark:

This command is not available for A2 mini.

Photo and Video

CMD_ID:0x0C-----Photo			
Send data format			
No.	Data Type	Data Name	Description
	uint8_t	func_type	0: Take a picture 1: Switch on / off HDR (not supported yet) 2: Start / Stop Recording 3: Motion – Lock Mode 4: Motion – Follow Mode 5: Motion – FPV Mode 6: Set video output as HDMI (Only available on A8 mini, restart gimbal to take effect) 7: Set video output as CVBS (Only available on A8 mini, restart gimbal to take effect) 8: Turn off both HDMI and CVBS video output (Only available on A8 mini, restart gimbal to take effect)
ACK data format			
			No ack

Mark:

This command is not available for A2 mini.

Acquire Gimbal Attitude

CMD_ID:0x0D-----Acquire Gimbal Attitude			
Send data format			
No.	Data Type	Data Name	Description

ACK data format			
	int16_t	yaw	Yaw axis degree
	int16_t	pitch	Pitch axis degree
	int16_t	roll	Roll axis degree
	int16_t	yaw_velocity	Yaw axis rotation speed
	int16_t	pitch_velocity	Pitch axis rotation speed
	int16_t	roll_velocity	Roll axis rotation speed

Mark

1. The above data to be divided by 10 is the actual degree, accuracy in one decimal place.
2. Under this command A2 mini can only acquire pitch attitude.

Set Gimbal Control Angle

CMD_ID:0x0E-----Set Gimbal Control Angle			
Send data format			
No.	Data Type	Data Name	Description
	int16_t	yaw	Target yaw angle
	int16_t	pitch	Target pitch angle
ACK data format			
	int16_t	yaw	Current yaw angle
	int16_t	pitch	Current pitch angle
	int16_t	roll	Current roll angle

Angle Control Range

Yaw:

- A8 mini: -135.0 ~ 135.0 degree
- A2 mini: Not available
- ZR10 / ZR30: Same with A8 mini
- ZT30: Limitless

Pitch

- A8 mini: -90.0 ~ 25.0 degree
- A2 mini / ZR10 / ZR30 / ZT30: Same with A8 mini

Mark:

1. The accuracy of the control angle is in one decimal place. Eg: Set yaw as 60.5 degrees, the command number should be set as 605.
2. The actual angle data returned to be divided by 10 is the actual degree, accuracy in one decimal place.

Acquire Camera Image Type

CMD_ID:0x10-----Acquire Camera Image Type			
Send data format			
No.	Data Type	Data Name	Description
ACK data format			
1	uint8_t	vdisp_mode	Camera Image Mode:

			0: Split Screen (Main: Zoom & Thermal. Sub: Wide Angle) 1: Split Screen (Main: Wide Angle & Thermal. Sub: Zoom) 2: Split Screen (Main: Zoom & Wide Angle. Sub: Thermal) 3: Single Image (Main: Zoom. Sub: Thermal) 4: Single Image (Main: Zoom. Sub: Wide Angle) 5: Single Image (Main: Wide Angle. Sub: Thermal) 6: Single Image (Main: Wide Angle. Sub: Zoom) 7: Single Image (Main: Thermal. Sub: Zoom) 8: Single Image (Main: Thermal. Sub: Wide Angle)
--	--	--	---

Mark:

Acquire camera image type command is only available for ZT30 at this moment.

Set Camera Image Type

CMD_ID:0x11-----Set Camera Image Type			
Send data format			
No.	Data Type	Data Name	Description
1	uint8_t	vdisp_mode	Camera Image Mode: 0: Split Screen (Main: Zoom & Thermal. Sub: Wide Angle) 1: Split Screen (Main: Wide Angle & Thermal. Sub: Zoom) 2: Split Screen (Main: Zoom & Wide Angle. Sub: Thermal) 3: Single Image (Main: Zoom. Sub: Thermal) 4: Single Image (Main: Zoom. Sub: Wide Angle) 5: Single Image (Main: Wide Angle. Sub: Thermal) 6: Single Image (Main: Wide Angle. Sub: Zoom) 7: Single Image (Main: Thermal. Sub: Zoom) 8: Single Image (Main: Thermal. Sub: Wide Angle)
ACK data format			
1	uint8_t	vdisp_mode	Camera Image Mode: 0: Split Screen (Main: Zoom & Thermal. Sub: Wide Angle) 1: Split Screen (Main: Wide Angle & Thermal. Sub: Zoom) 2: Split Screen (Main: Zoom & Wide Angle. Sub: Thermal) 3: Single Image (Main: Zoom. Sub:

			Thermal) 4: Single Image (Main: Zoom. Sub: Wide Angle) 5: Single Image (Main: Wide Angle. Sub: Thermal) 6: Single Image (Main: Wide Angle. Sub: Zoom) 7: Single Image (Main: Thermal. Sub: Zoom) 8: Single Image (Main: Thermal. Sub: Wide Angle)
--	--	--	--

Mark:

Set camera image type command is only available for ZT30 at this moment.

Read Temperature of a Point

CMD_ID:0x12-----Read Temperature of a Point			
Send data format			
No.	Data Type	Data Name	Description
1	uint16_t	x	X coordinate of the point
2	uint16_t	y	Y coordinate of the point
3	uint8_t	get_temp_flag	0: Turn off temperature measuring 1: Measure the temperature once 2: Continuous temperature measuring at 5 Hz
ACK data format			
1	uint16_t	temp	Temperature of the point / 100 (two decimal places)
2	uint16_t	x	X coordinate of the point
3	uint16_t	y	Y coordinate of the point

Mark:

Read temperature of a point command is only available for ZT30 at this moment.

Read Temperature of a Box on Screen

CMD_ID:0x13-----Read Temperature of a Box on Screen			
Send data format			
No.	Data Type	Data Name	Description
1	uint16_t	startx	X coordinate of the starting point of the box
2	uint16_t	starty	Y coordinate of the starting point of the box
3	uint16_t	endx	X coordinate of the ending point of the box
4	uint16_t	endy	Y coordinate of the ending point of the box

5	uint8_t	get_temp_flag	0: Turn off temperature measuring 1: Measure the temperature once 2: Continuous temperature measuring at 5 Hz
ACK data format			
1	uint16_t	startx	X coordinate of the starting point of the box
2	uint16_t	starty	Y coordinate of the starting point of the box
3	uint16_t	endx	X coordinate of the ending point of the box
4	uint16_t	endy	Y coordinate of the ending point of the box
5	uint16_t	temp_max	Max temperature in the box / 100 (two decimal places)
6	uint16_t	temp_min	Min temperature in the box / 100 (two decimal places)
7	uint16_t	temp_max_x	X coordinate of the max temperature in the box
8	uint16_t	temp_max_y	Y coordinate of the max temperature in the box
9	uint16_t	temp_min_x	X coordinate of the min temperature in the box
10	uint16_t	temp_min_x	Y coordinate of the min temperature in the box

Mark:

1. Thermal camera supports digital zoom, the temperature measuring box will zoom in and out according to the digital zoom. Under digital zoom, the temperature measuring range should refer to the box responded by the camera.
2. Read temperature of a box command is only available for ZT30 at this moment.

Read Temperature of the Full Screen

CMD_ID:0x14-----Read Temperature of the Full Screen			
Send data format			
No.	Data Type	Data Name	Description
1	uint8_t	get_temp_flag	0: Turn off temperature measuring 1: Measure the temperature once 2: Continuous temperature measuring at 5 Hz
ACK data format			
1	uint16_t	temp_max	Max temperature of the full screen / 100 (two decimal places)
2	uint16_t	temp_min	Min temperature of the full screen / 100 (two decimal places)
3	uint16_t	temp_max_x	X coordinate of the max temperature in the full screen
4	uint16_t	temp_max_y	Y coordinate of the max temperature in the full screen
5	uint16_t	temp_min_x	X coordinate of the min temperature in

			the full screen
6	uint16_t	temp_min_x	Y coordinate of the min temperature in the full screen

Mark:

Read temperature of the full screen is only available for ZT30 at this moment.

Read Range from Laser Rangefinder

CMD_ID:0x15-----Read Range from Laser Rangefinder			
Send data format			
No.	Data Type	Data Name	Description
ACK data format			
1	uint16_t	info_type	Range from Laser Rangefinder low byte in the front, high byte in the back Minimum value is 50 Data unit is dm

Mark:

Read range from laser rangefinder is only available for ZT30 at this moment.

3.3.3 SDK Communication Interface

UDP

- IP: 192.168.144.25
- Port Number: 37260

TCP

- IP: 192.168.144.25
- Port Number: 37260
- Heartbeat Package Data: 55 66 01 01 00 00 00 00 00 59 8B

3.3.4 SIYI Gimbal Camera SDK Communication Code Examples

Zoom 1

55 66 01 01 00 00 00 05 01 8d 64

Zoom -1

55 66 01 01 00 00 00 05 FF 5c 6a

Absolute Zoom (4.5X)

55 66 01 02 00 01 00 0F 04 05 60 BB

Acquire the Max Zoom Value

55 66 01 00 00 00 00 16 B2 A6

Manual Focus 1

55 66 01 01 00 00 00 06 01 de 31

Manual Focus -1

55 66 01 01 00 00 00 06 ff 0f 3f

Take Pictures

55 66 01 01 00 00 00 0c 00 34 ce

Record Video

55 66 01 01 00 00 00 0c 02 76 ee

Rotate 100 100

55 66 01 02 00 00 00 07 64 64 3d cf

Auto Centering

55 66 01 01 00 00 00 08 01 d1 12

Gimbal Status Information

55 66 01 00 00 00 00 0a 0f 75

Auto Focus

55 66 01 01 00 00 00 04 01 bc 57

Acquire Hardware ID

55 66 01 00 00 00 00 02 07 f4

Acquire Firmware Version

55 66 01 00 00 00 00 01 64 c4

Lock Mode

55 66 01 01 00 00 00 0c 03 57 fe

Follow Mode

55 66 01 01 00 00 00 0c 04 b0 8e

FPV Mode

55 66 01 01 00 00 00 0c 05 91 9e

Acquire Attitude Data

55 66 01 00 00 00 00 0d e8 05

Set Video Output as HDMI (Only available on A8 mini, restart to take effect)

55 66 01 01 00 00 00 0c 06 f2 ae

Set Video Output as CVBS (Only available on A8 mini, restart to take effect)

55 66 01 01 00 00 00 0c 07 d3 be

Turn Off both CVBS and HDMI Output (Only available on A8 mini, restart to take effect)

55 66 01 01 00 00 00 0c 08 3c 4f

Read Range from Laser Rangefinder (Low byte in the front, high byte in the back, available on ZT30)

55 66 01 00 00 00 00 15 D1 96

3.3.5 SDK CRC16 Code

```
const uint16_t crc16_tab[256];
/*****
CRC16 Coding & Decoding G(X) = X^16+X^12+X^5+1
*****/
uint16_t CRC16_cal(uint8_t *ptr, uint32_t len, uint16_t crc_init)
{
    uint16_t crc,   oldcrc16;
    uint8_t  temp;
    crc = crc_init;
    while (len--!=0)
    {
        temp=(crc>>8)&0xff;
        oldcrc16=crc16_tab[*ptr^temp];
        crc=(crc<<8)^oldcrc16;
        ptr++;
    }
    //crc=~crc;    //??
    return(crc);
}

uint8_t crc_check_16bites(uint8_t* pbuf, uint32_t len, uint32_t* p_result)
{
    uint16_t crc_result = 0;
    crc_result= CRC16_cal(pbuf,len, 0);
    *p_result = crc_result;
}
```

```

return 2;
}

const uint16_t crc16_tab[256]= {0x0,0x1021,0x2042,0x3063,0x4084,0x50a5,0x60c6,0x70e7,
                                0x8108,0x9129,0xa14a,0xb16b,0xc18c,0xd1ad,0xe1ce,0xf1ef,
                                0x1231,0x210,0x3273,0x2252,0x52b5,0x4294,0x72f7,0x62d6,
                                0x9339,0x8318,0xb37b,0xa35a,0xd3bd,0xc39c,0xf3ff,0xe3de,
                                0x2462,0x3443,0x420,0x1401,0x64e6,0x74c7,0x44a4,0x5485,
                                0xa56a,0xb54b,0x8528,0x9509,0xe5ee,0xf5cf,0xc5ac,0xd58d,
                                0x3653,0x2672,0x1611,0x630,0x76d7,0x66f6,0x5695,0x46b4,
                                0xb75b,0xa77a,0x9719,0x8738,0xf7df,0xe7fe,0xd79d,0xc7bc,
                                0x48c4,0x58e5,0x6886,0x78a7,0x840,0x1861,0x2802,0x3823,
                                0xc9cc,0xd9ed,0xe98e,0xf9af,0x8948,0x9969,0xa90a,0xb92b,
                                0x5af5,0x4ad4,0x7ab7,0x6a96,0x1a71,0xa50,0x3a33,0x2a12,
                                0xdbfd,0xcdbc,0xfbbf,0xeb9e,0x9b79,0x8b58,0xbb3b,0xab1a,
                                0x6ca6,0x7c87,0x4ce4,0x5cc5,0x2c22,0x3c03,0xc60,0x1c41,
                                0xedae,0xfd8f,0xcdec,0xddcd,0xad2a,0xbd0b,0x8d68,0x9d49,
                                0x7e97,0x6eb6,0x5ed5,0x4ef4,0x3e13,0x2e32,0x1e51,0xe70,
                                0xff9f,0xefbe,0xdfdd,0xcffc,0xbf1b,0xaf3a,0x9f59,0x8f78,
                                0x9188,0x81a9,0xb1ca,0xa1eb,0xd10c,0xc12d,0xf14e,0xe16f,
                                0x1080,0xa1,0x30c2,0x20e3,0x5004,0x4025,0x7046,0x6067,
                                0x83b9,0x9398,0xa3fb,0xb3da,0xc33d,0xd31c,0xe37f,0xf35e,
                                0x2b1,0x1290,0x22f3,0x32d2,0x4235,0x5214,0x6277,0x7256,
                                0xb5ea,0xa5cb,0x95a8,0x8589,0xf56e,0xe54f,0xd52c,0xc50d,
                                0x34e2,0x24c3,0x14a0,0x481,0x7466,0x6447,0x5424,0x4405,
                                0xa7db,0xb7fa,0x8799,0x97b8,0xe75f,0xf77e,0xc71d,0xd73c,
                                0x26d3,0x36f2,0x691,0x16b0,0x6657,0x7676,0x4615,0x5634,
                                0xd94c,0xc96d,0xf90e,0xe92f,0x99c8,0x89e9,0xb98a,0xa9ab,
                                0x5844,0x4865,0x7806,0x6827,0x18c0,0x8e1,0x3882,0x28a3,
                                0xcb7d,0xdb5c,0xeb3f,0xfb1e,0x8bf9,0x9bd8,0xabbb,0xbb9a,
                                0x4a75,0x5a54,0x6a37,0x7a16,0xaf1,0x1ad0,0x2ab3,0x3a92,
                                0xfd2e,0xed0f,0xdd6c,0xcd4d,0xbdaa,0xad8b,0x9de8,0x8dc9,
                                0x7c26,0x6c07,0x5c64,0x4c45,0x3ca2,0x2c83,0x1ce0,0xcc1,
                                0xef1f,0xff3e,0xcf5d,0xdf7c,0xaf9b,0xbfba,0x8fd9,0x9ff8,
                                0x6e17,0x7e36,0x4e55,0x5e74,0x2e93,0x3eb2,0xed1,0x1ef0
};

```

3.3.6 Advanced Guide for SIYI Gimbal SDK Integration

This special guide is to help developers (especially whose development is based on Linux platform) use SIYI gimbal SDK.

Mark

Before using the guide, please do read the chapter 3.3.1 to 3.3.5 of the user manual.

This guide is using UDP protocol:

1. Go to chapter 3.3.4 of this manual for SIYI Gimbal Camera SDK Communication Code Examples and fill your required examples to "send_buff" following the below format in hexadecimal.

```
int sockfd;
int ret, i, recv_len;
struct sockaddr_in send_addr, recv_addr;
unsigned char send_buff[] = {0x55,0x66,0x01,0x01,0x00,0x00,0x00,0x08,0x01,0xd1,0x12}; //对应功能的帧协议,十六进制数据
unsigned char recv_buff[RECV_BUUF_SIZE] = {0};
/* 创建UDP套接字
```

2. Chang the gimbal camera's server port and IP addresses to what you need. The double quotation marks of the IP addresses should be kept.

```
#define SERVER_PORT 37260 //云台相机（服务端）端口号
#define SERVER_IP "192.168.1.25" //云台相机（服务端）IP
```

3. Create a socket keyword.

```
/* 创建UDP套接字
   AF_INET: ipv4地址
   SOCK_DGRAM: UDP 协议
   0: 自动选择类型对应的默认协议
*/
if ((sockfd = socket(AF_INET, SOCK_DGRAM, 0)) < 0) {
    perror("socket");
    exit(1);
}
```

4. Send data to the gimbal camera and do not revise.

```
/* 发送帧数据
   sockfd: socket套接字文件描述符
   send_buff: 要发送的数据在内存中的首地址
   sizeof(send_buff): 要发送的数据的长度
   0: 发送标志, 一般为0
   (struct sockaddr *)&send_addr: 数据接收端的地址 (包含IP地址和端口号) 的结构体指针
   addr_len: 数据接收端地址结构体的大小
*/
printf("Send HEX data\n");
socklen_t addr_len = sizeof(struct sockaddr_in);
if(sendto(sockfd, send_buff, sizeof(send_buff), 0, (struct sockaddr *)&send_addr, addr_len) < 0)
{
    perror("sendto");
    exit(1);
}
```

5. Receive data responded by the gimbal camera and do not revise.

```

/* 发送帧数据
sockfd:          socket套接字文件描述符
send_buf:       要发送的数据在内存中的首地址
sizeof(send_buf): 要发送的数据的长度
0:              发送标志, 一般为0
(struct sockaddr *)&send_addr: 数据接收端的地址 (包含IP地址和端口号) 的结构体指针
addr_len:       数据接收端地址结构体的大小
*/
printf("Send HEX data\n");
socklen_t addr_len = sizeof(struct sockaddr_in);
if(sendto(sockfd, send_buf, sizeof(send_buf), 0, (struct sockaddr *)&send_addr, addr_len) < 0)
{
    perror("sendto");
    exit(1);
}

```

6. Print the received data in hexadecimal and do not revise.

```

// 十六进制形式打印接收到的数据
printf("Received HEX data: ");
for (int i = 0; i < recv_len; i++)
{
    printf("%02x ", recv_buf[i]);
}
printf("\n");

```

7. Following the above steps, compile and run the SDK and you will see the printed data below, which means data can be sent and received normally. At this moment, please observe if the gimbal camera executes the relevant actions.

```

yang@ubuntu:~/_star$ gcc siyi.c -o siyi
yang@ubuntu:~/_star$ ./siyi
Send HEX data
Received HEX data: 55 66 02 01 00 08 00 08 01 90 4f
yang@ubuntu:~/_star$

```

Mark

Before using the SDK to communicate with the gimbal camera in UDP protocol, please do make sure that the device and the gimbal camera are in the same gateway, which means that ubuntu can ping the gimbal camera's IP addresses successfully.

If they still didn't communicate, the possible reason is that the Windows firewall is interrupting the sending and receiving of data, then try to disable Windows firewall temporarily.

Relevant Code Examples

```

#include <stdio.h>
#include <stdlib.h>
#include <string.h>
#include <errno.h>
#include <sys/socket.h>
#include <netinet/in.h>
#include <arpa/inet.h>
#include <unistd.h>

#define RECV_BUUF_SIZE    64
#define SERVER_PORT      37260           // Gimbal Camera (Server) Port
#define SERVER_IP        "192.168.144.25" // Gimbal Camera (Server) IP Addresses

```

```

int main(int argc, char *argv[])
{
    int sockfd;
    int ret, i, recv_len;
    struct sockaddr_in send_addr, recv_addr;
    unsigned char send_buf[] = {0x55,0x66,0x01,0x01,0x00,0x00,0x00,0x08,0x01,0xd1,0x12}; // Frame
    protocol of the relevant functions in hexadecimal
    unsigned char recv_buf[RECV_BUUF_SIZE] = {0};

    /* Create UDP Socket
       AF_INET:    ipv4 addresses
       SOCK_DGRAM: UDP protocol
       0:          automatically choose the default protocol of the relevant type
    */
    if ((sockfd = socket(AF_INET, SOCK_DGRAM, 0)) < 0) {
        perror("socket");
        exit(1);
    }

    /* Set IP addresses and port number of gimbal camera
       sin_family:    ipv4 addresses
       sin_addr.s_addr: IP addresses of gimbal camera
       sin_port:      port of gimbal camera
    */
    memset(&send_addr, 0, sizeof(send_addr));
    send_addr.sin_family = AF_INET;
    send_addr.sin_addr.s_addr = inet_addr(SERVER_IP);
    send_addr.sin_port = htons(SERVER_PORT);

    /* Send frame data
       sockfd:          descriptor of socket
       send_buf:        head address in RAM of the sending data
       sizeof(send_buf): length of sending data
       0:                sending mark, usually it is 0
       (struct sockaddr *)&send_addr: structure pointer of the receiving data addresses
       (including IP addresses and port)
       addr_len:        structure size of the receiving data addresses
    */
    printf("Send HEX data\n");
    socklen_t addr_len = sizeof(struct sockaddr_in);
    if(sendto(sockfd, send_buf, sizeof(send_buf), 0, (struct sockaddr *)&send_addr, addr_len) < 0)
    {
        perror("sendto");
        exit(1);
    }
}

```

```

}

/* Receive the responding data from gimbal camera
sockfd:                descriptor of "sockfd" socket
recv_buf:              head address in RAM of the responding data
RECV_BUUF_SIZE:       size of the buffer, which is the length of the max data to
receive
0:                    receiving mark, usually it is 0
(struct sockaddr *)&recv_addr:  the target structure will be filled with addresses (including
IP addresses and port) from the data sender
&addr_len:            the target storage position, the structure size of
"src_addr" and "addrlen" should be filled before calling, the actual size of the sender will be filled after calling

*/
recv_len = recvfrom(sockfd, recv_buf, RECV_BUUF_SIZE, 0, (struct sockaddr *)&recv_addr,
&addr_len);
if (recv_len < 0) {
    perror("recvfrom");
    exit(1);
}

// print the received data in hexadecimal
printf("Received HEX data: ");
for (int i = 0; i < recv_len; i++)
{
    printf("%02x ", recv_buf[i]);
}
printf("\n");

// close socket
close(sockfd);

return 0;
}

```

3.4 Control in SIYI QGC Windows Software through HM30 Image Transmission System

Gimbal connects to air unit directly to control gimbal rotation, gimbal functions, and video display in SIYI QGC Windows software when the air unit is communicating

with the ground unit.

3.4.1 Preparation

It is necessary to prepare tools, firmware, and software below before controlling gimbal camera in this way.

- SIYI HM30 Full HD Image Transmission System
- A2 mini FPV Gimbal

Mark

Above products can be purchased from SIYI directly or from SIYI authorized dealers.

- HM30 Ground Unit LAN to RJ45 Cable

Mark

Above tools come with product package.

- SIYI QGC Windows Software

Mark

Above software can be downloaded from relevant product page on SIYI official website.

Steps for SIYI QGC Windows

1. Power air unit and bind it with ground unit.
2. Connect the air unit's Ethernet port to the gimbal.
3. Then use HM30 Ground Unit LAN to RJ45 cable to connect the ground unit's LAN port with the computer's RJ45 port.
4. Modify the computer's Ethernet settings to have the same gateway with SIYI link and avoid IP addresses conflict.

For example, let's assign "192.168.144.30" for the computer IP addresses.



5. Run SIYI QGC Windows software, go to "Comm Links – Video Settings", and select "RTSP Video Stream" for "Source", then enter the default RTSP addresses of SIYI gimbal camera, video stream will display. Gimbal motion and camera functions can be controlled by mouse in QGroundControl.

3.4.2 Gimbal Pitch Rotation

While SIYI QGC Windows software is running,

Drag the mouse on screen can control gimbal rotation. Dragging the mouse up and down are pitch rotation.

Double click the mouse on screen, gimbal will automatically center.

Mark

Drag the mouse on screen and hold it, gimbal will continue rotating unless there is a physical limit. Farther you hold it from the center of the screen, faster the gimbal rotates.

4 VIDEO OUTPUT

A2 mini gimbal can only output video through Ethernet port.

4.1 Output and Display Video Stream on SIYI Ground Station

Gimbal camera can connect to the air unit directly, then video will be displayed in SIYI FPV app or SIYI QGC app or other app that are compatible with SIYI link and SIYI gimbal camera when the air unit is communicating with the ground station.

Please refer to chapter 3.1 of this manual for more detail.

4.2 Output Video Stream to Android Device through HM30 Full HD Image Transmission System

Gimbal connects to HM30 air unit directly, then video will be displayed in SIYI FPV app or SIYI QGC app or other app that are compatible with SIYI link and SIYI gimbal camera when the air unit is communicating with the ground unit.

Preparation

It is necessary to prepare the tools, firmware, and software below before outputting video stream in this way.

- HM30 Full HD Image Transmission System
- A2 mini FPV Gimbal

Mark

Above products can be purchased from SIYI directly or from SIYI authorized dealers.

- SIYI FPV App (v2.5.12.572 or latest version)
- SIYI QGC App

Mark

Above software can be downloaded from relevant product page on SIYI official website.

SIYI FPV App Steps

1. Power air unit and bind it with ground unit.
2. Connect the air unit's Ethernet port with the gimbal.
3. Update SIYI FPV app to the latest.
4. Run SIYI FPV app, go to "Settings" and select the relevant SIYI camera type with main / sub stream, video stream will display. Gimbal motion and camera functions can be controlled by app touchscreen.

SIYI QGC App Steps

1. Power air unit and bind it with ground unit.
2. Connect the air unit's Ethernet port with the gimbal.
3. Run SIYI QGC app, go to "Comm Links – Video Settings", and select "RTSP Video Stream" for "Source", then enter the default RTSP addresses of SIYI gimbal camera, video stream will display. Gimbal motion and camera functions can be controlled by ground station touchscreen.

4.3 Output Video Stream to Windows Device through HM30 Full HD Image Transmission System

Gimbal connects to HM30 air unit directly, then video will be displayed in SIYI QGC Windows software when the air unit is communicating with the ground unit.

Please refer to chapter 3.4 of this manual for details.

4.4 Output to Third-Party Links

A2 mini gimbal can output video stream to third-party image transmission systems which provide Ethernet port and are compatible with RTSP video stream.

In this way, it is necessary to prepare a customized link cable for connection between SIYI gimbal camera and the third-party image transmission system.



CAUTION

The “RX-” pinout on SIYI gimbal’s video port should connect to the image transmission system video port’s “RX-” pinout, and “RX+” pinout to “RX+” pinout. Do not cross the pinouts, otherwise it will cause damage to the device.

Steps

1. Power the air unit of the image transmission system and bind it with the ground unit.

2. Connect gimbal's Ethernet port to the third-party link's Ethernet port.
3. Open RTSP video player and input SIYI gimbal's default RTSP addresses (rtsp://192.168.144.25:8554/main.264), if video displays normally, connection is successful.

Mark

The default RTSP addresses of A2 mini gimbal is (rtsp://192.168.144.25:8554/main.264) and it cannot be modified.

4.5 Solutions to No Image

If gimbal camera failed to output video or the video cannot be displayed properly, please follow the steps below for trouble shooting.

1. Confirm if the link's ground unit is communicating with the air unit and if the camera is connected to the air unit.
2. Check Camera IP addresses and RTSP addresses.
3. If you are using SIYI FPV app, check the connection status, app version, video stream settings.
4. If you are using SIYI handheld ground stations, check the Ethernet switch in Android system.
5. Please double check if the gimbal camera's IP addresses was modified accidentally.

If video still does not show up, please follow the steps below and make a deep investigation according to the video output mode, the video display device, and the application / software you are using.

4.5.1 Video Output to Android Device

1. Input SIYI gimbal’s default IP addresses “192.168.144.25” in the “Ping Tools” app and check if the network communication is successful. If the tool responds, then check if the RTSP address in the application / software is correct.



Successful Network Communication



Network Communication Failed

2. If the network communication is failed, then check the communication between the link's ground unit and the air unit. If the communication is good, then check if the video cable between the camera and the link's air unit is good, and if the voltage input is in normal range.

4.5.2 Video Output to Windows Device

1. Use the "Win + R" key combo to wake up the "Run" program and input the command "cmd".

```

管理员: C:\Windows\system32\cmd.exe
Microsoft Windows [版本 10.0.19042.804]
(c) 2020 Microsoft Corporation. 保留所有权利。

C:\Users\Administrator>ping 192.168.144

正在 Ping 192.168.0.144 具有 32 字节的数据:
Control-C
^C
C:\Users\Administrator>ping 192.168.144.25

正在 Ping 192.168.144.25 具有 32 字节的数据:
来自 192.168.144.25 的回复: 字节=32 时间=9ms TTL=64
来自 192.168.144.25 的回复: 字节=32 时间=3ms TTL=64
来自 192.168.144.25 的回复: 字节=32 时间=4ms TTL=64
来自 192.168.144.25 的回复: 字节=32 时间=3ms TTL=64

```

Successful Network Communication

```

管理员: C:\Windows\system32\cmd.exe

正在 Ping 192.168.144.25 具有 32 字节的数据:
Control-C
^C
C:\Users\Administrator>ping 192.168.144.25

正在 Ping 192.168.144.25 具有 32 字节的数据:
请求超时。
请求超时。
来自 192.168.144.153 的回复: 无法访问目标主机。
来自 192.168.144.153 的回复: 无法访问目标主机。

192.168.144.25 的 Ping 统计信息:
    数据包: 已发送 = 4, 已接收 = 2, 丢失 = 2 (50% 丢失),
C:\Users\Administrator>

```

Network Communication Failed

2. Input SIYI gimbal camera’s default IP addresses “192.168.144.25” and press the “Enter” key to check if the communication is successful. If it is, please check the RTSP addresses in the software or try to switch to another software.
3. If the network didn’t connect, then check the communication between the link’s ground unit and the air unit. If the communication is successful, then check if the video cable between the camera and the link’s air unit is good, and if the voltage input is in normal range.

 **Mark**

If you have done all trouble shooting by following the steps above and still didn't solve the problem, then please contact your dealer, or contact SIYI Support directly.

4.6 Common IP Addresses

SIYI Optical Pod / Gimbal Camera's Default IP Addresses: 192.168.144.25

(OLD) SIYI Optical Pod / Gimbal Camera's Default RTSP Addresses:

rtsp://192.168.144.25:8554/main.264

(NEW) SIYI FPV App's Private Video Stream Protocol's Addresses:

- SIYI Camera 1 Main Stream: 192.168.144.25: 37256
- SIYI Camera 1 Sub Stream: 192.168.144.25: 37255
- SIYI Camera 2 Main Stream: 192.168.144.26: 37256
- SIYI Camera 2 Sub Stream: 192.168.144.26: 37255

 **Mark**

SIYI cameras released after ZT30 (including ZT30) start to use the new addresses.

SIYI cameras released before ZT30 still use the old addresses, including ZR30, A2 mini, A8 mini, ZR10, R1M Recording FPV Camera, etc.

5 SIYI FPV APP

SIYI FPV is an Android application developed by SIYI to configure many SIYI products for video display, camera stream settings, and communication link status monitoring.

Mark

This chapter is edited based on SIYI FPV App v2.5.12.572.

SIYI FPV App can be download from the relevant product pages on SIYI official website.

SIYI FPV App compatible SIYI devices.

- ZT30 Four-Sensor Optical Pod
- ZR30 4K AI 180X Hybrid Zoom Optical Pod
- A2 mini Ultra-Wide-Angle FPV Gimbal
- MK32 / MK32E Enterprise Handheld Ground Station
- A8 mini AI Zoom Gimbal Camera
- ZR10 2K 30X Hybrid Zoom Optical Pod
- R1M HD Recording FPV Camera
- Air Unit HDMI Input Converter
- HM30 Full HD Image Transmission System
- MK15 / MK15E Mini Handheld Ground Station

SIYI FPV App OSD Information Definition

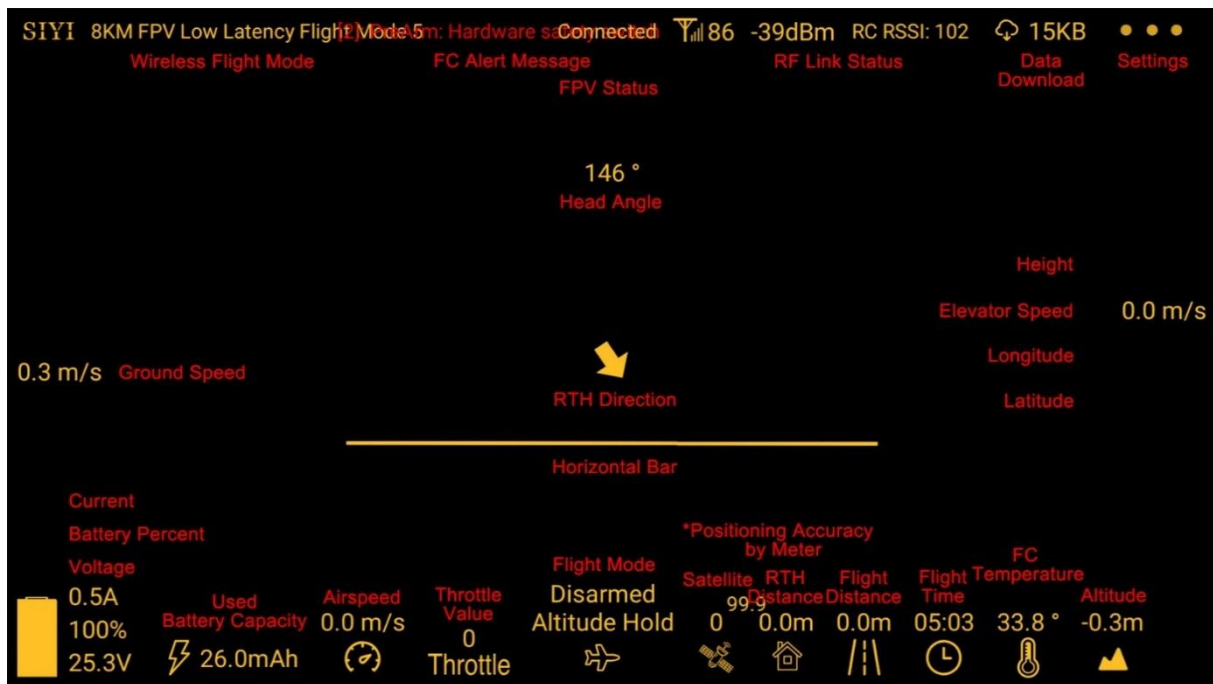

SIYI FPV Camera Function Icon Definition



5.1 Settings

In “Settings” page, you can select camera type with stream type, select or input video stream IP addresses, custom app interface, and switch video decoding type.

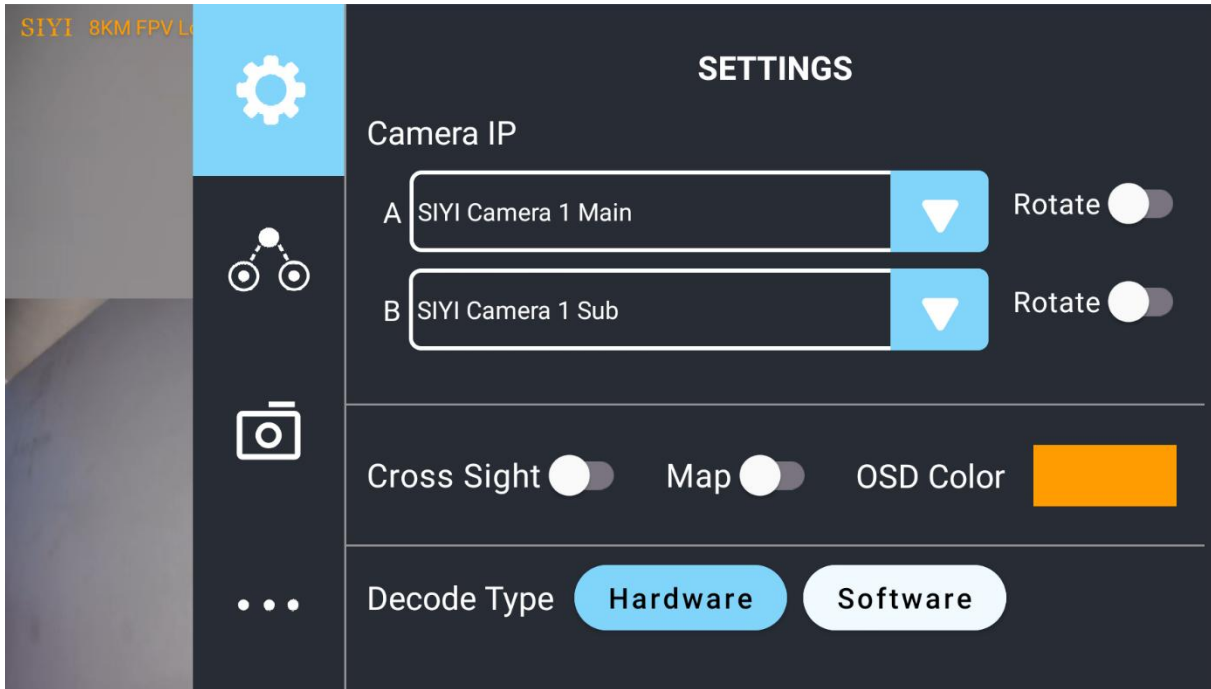

About Settings

Camera IP: Select between SIYI Camera 1 and SIYI Camera 2, between main stream and sub stream, select or input video stream RTSP addresses, disable image, or rotate the relevant image in 180 degrees.

Cross Sight: Enable / disable a cross sight in the center of the image.

Map: Enable / disable the map box over the left-bottom corner of the image.

OSD Color: Custom the color of all OSD information.

Decoding Type: Switch between “Hardware Decoding” and “Software Decoding”. Please refer to your camera and your device to display video for the best decoding type.

5.2 Link Status

Display the link status directly over the FPV image.

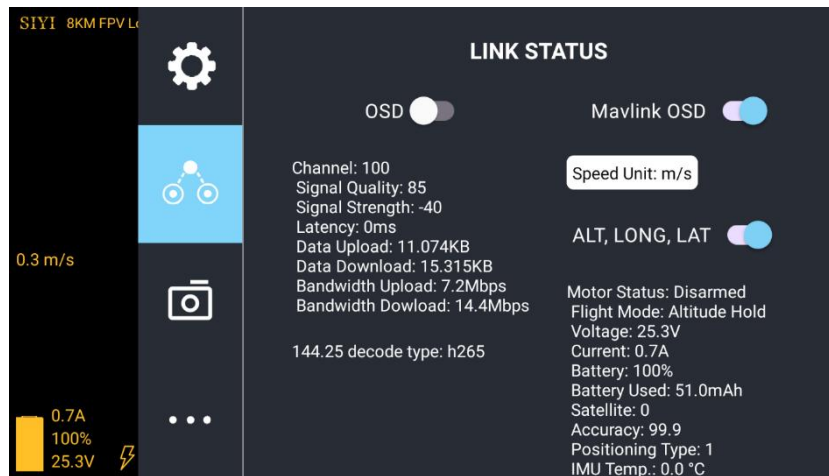

About Link Status

OSD: Enable / disable standard OSD information.

Mavlink OSD: Enable / disable Mavlink OSD information.

Speed Unit: Switch speed unit between meter per seconds and kilometer per hour.

Longitude and Latitude: Enable / disable information.

5.3 Gimbal Camera

Configure the basic functions for SIYI gimbal cameras and cameras.

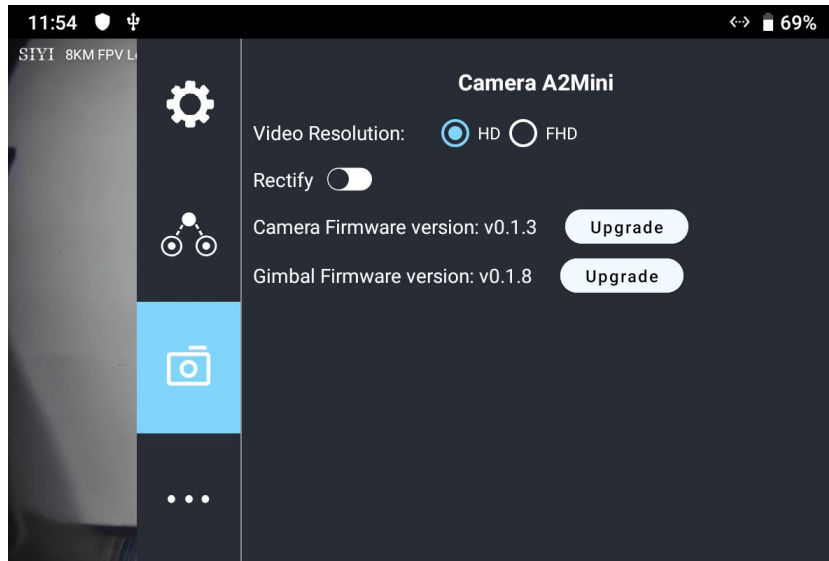

About Gimbal Camera

Video Resolution: Switch camera real-time streaming resolution between HD (720p) and Full HD (1080p).

Distortion Correction: Turn on/off A2 mini gimbal’s distortion correction function.

Camera Firmware Version: Display the current camera firmware version.

Gimbal Firmware Version: Display the current gimbal firmware version.

Firmware Upgrade

A2 mini gimbal supports firmware upgrade through “SIYI FPV” app.

Before upgrade, it is necessary to prepare the tools, software, and firmware below.

- MK15 Mini Handheld Smart Controller

 **Mark**

You can also use MK32 Enterprise Ground Station, HM30 Full HD Image Transmission System, or compatible third-party links for A2 mini gimbal's firmware upgrade.

- SIYI FPV App (v2.5.12.572 or latest version)
- Camera Firmware
- Gimbal Firmware

 **Mark**

About tools and firmware can be downloaded from the relevant product pages on SIYI official website.

Firmware Upgrade Steps

1. Install the latest SIYI FPV app on your MK15 remote controller and save the firmware files into MK15 Android system storage in advance.
2. Make sure that MK15 remote controller is communicating with the air unit and A2 mini gimbal is already connected to the air unit.
3. Run SIYI FPV app, go to "Camera A2 mini" page.

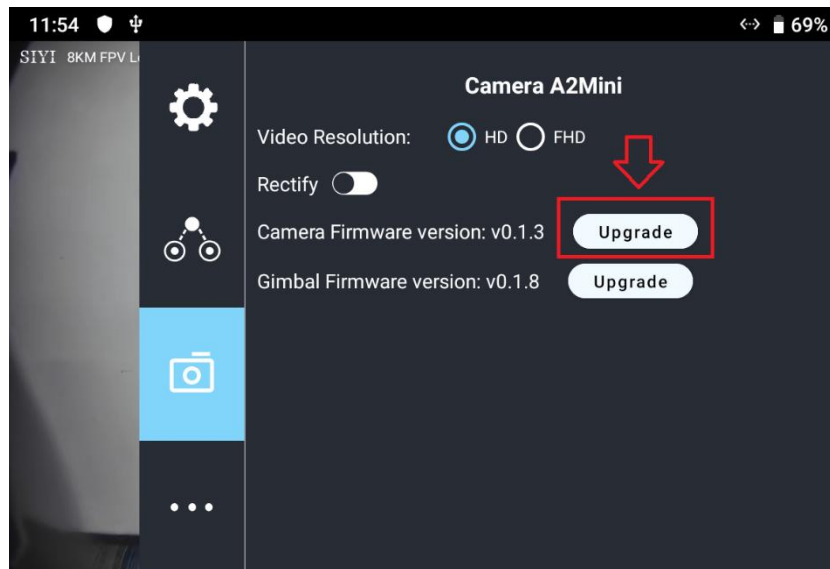

4. Tap the “Upgrade” button after the firmware upgrade option and find the relevant firmware.

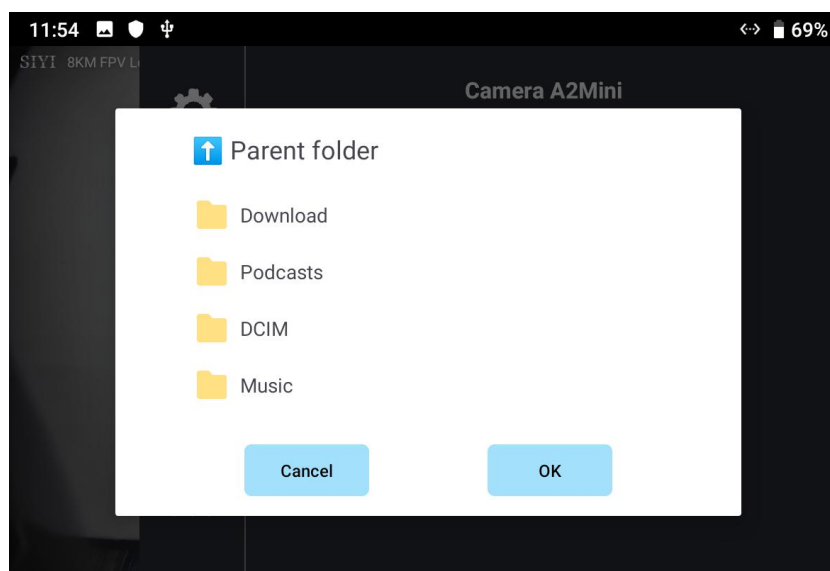

5. Select the firmware and tap “OK”, and wait for “Upgrade Successful”. Then restart SIYI FPV app to confirm if the firmware is already the latest.

5.4 About SIYI FPV

Displays the software version of SIYI FPV and common contact information of SIYI Technology.

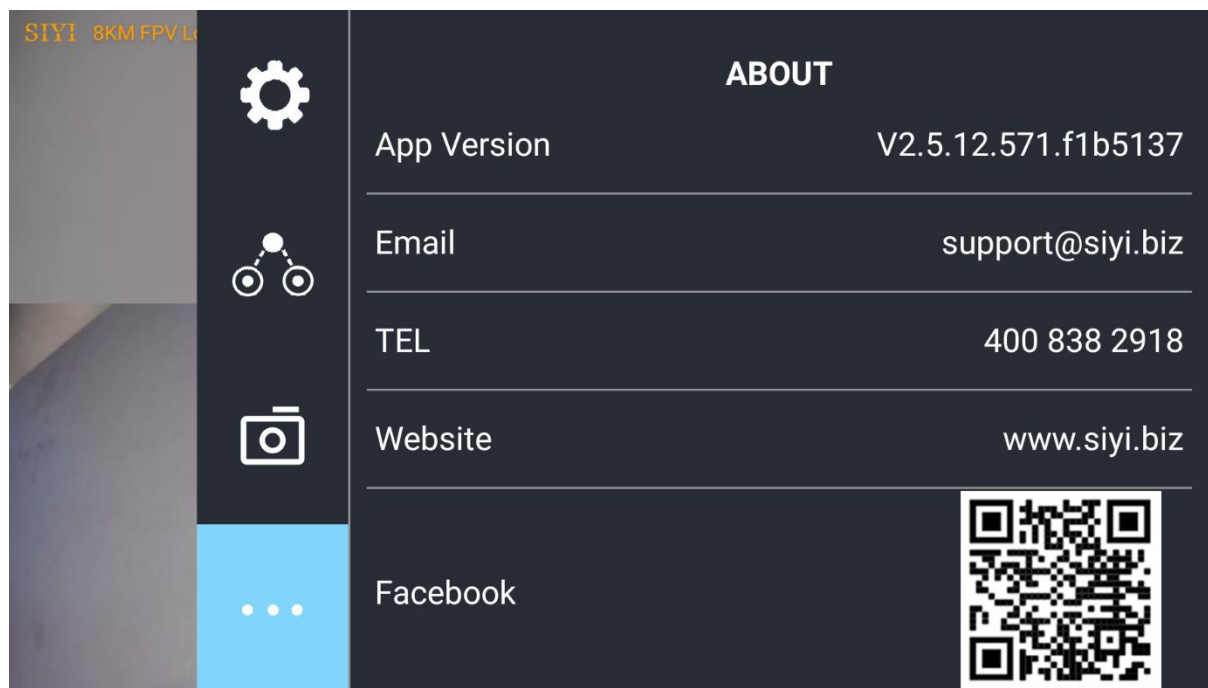

6 After-sale Service

If there were any questions or problems using SIYI Technology's product, you can always try to send an email to SIYI Official A/S Center (support@siyi.biz) or consult your sales representative or dealer for answers or solutions.

6.1 Repair Service

If your purchased SIYI products cannot work properly, please contact SIYI Official A/S Center for consulting.

Usually there are two situations for acquiring repair service.

- Product Defect
- Product Damage

SIYI products under the two situations can be sent back to SIYI for repairing. Defect products with valid warranty can be repaired for free. Defect products without valid warranty or damaged products should be charged of repair fees after repairing. Please refer to SIYI's Official A/S Quotation for detail.

6.2 Warranty

SIYI Technology guarantees that, subject to the following conditions, Return & Refund Service, Replacement Service, and Warranty Repair Service can be requested. Please contact SIYI directly (support@siyi.biz or your sales manager) or authorized SIYI dealer for more detail.

6.2.1 7-Day Return & Refund

You can request Return & Refund Service:

Within seven (7) days of receiving a product if the product has no manufacturing defect, has not been activated and is still in new or like-new condition.

Within seven (7) days of receiving a product if the product has a manufacturing defect.

Return & Refund Service will not be provided where:

It is requested beyond seven (7) calendar days of receiving a product.

A product sent to SIYI for Return & Refund Service does not include all original accessories, attachments or packaging, or any item is not in new or like-new condition, i.e., with cracks, dents, or scratches.

A legal proof of purchase, receipt or invoice is not provided or is reasonably believed to have been forged or tampered with.

Any fault or damage of the product is caused by unauthorized use or modification of the product, including exposure to moisture, entry of foreign bodies (water, oil, sand, etc.) or improper installation or operation.

Product labels, serial numbers, waterproof marks, etc. show signs of tampering or alteration.

Damage is caused to the product by uncontrollable external factors, including fire, floods, high winds, or lightning strikes.

A product is not delivered to SIYI within seven (7) calendar days after Return & Refund Service confirmation is sent from SIYI.

Other circumstances stated in this policy.

6.2.2 15-Day Replacement

You can request Replacement Service:

Within fifteen (15) calendar days of receiving the product if the product has sustained a substantial damage in transit, provided always that the damage proof issued by the carrier can be provided to SIYI.

Within fifteen (15) calendar days of receiving the product if the product does not match the original description of the product in one or more significant respects.

Within fifteen (15) calendar days of receiving the product if the product suffers performance failure.

Replacement Service will not be provided where:

Service is requested more than fifteen (15) calendars days after receiving a product.

Legal proof-of-purchase, receipts, or invoices are not provided, or are reasonably believed to have been forged or tampered with.

A product sent to SIYI for replacement does not include all original accessories, attachments, and packaging, or contains items damaged by user error.

A product is found to have no defects after all appropriate tests are conducted by SIYI.

Any fault or damage of the product is caused by unauthorized use or modification of the product, including exposure to moisture, entry of foreign bodies (water, oil, sand, etc.) or improper installation or operation.

Damage is caused by uncontrollable external factors, including fires, floods, high winds, or lightning strikes.

Received product has not been sent back to SIYI seven (7) calendar days after replacement confirmation from SIYI.

Proof of damage during transit issued by the carrier cannot be provided.

Other circumstances stated in this policy.

6.2.3 1-Year Warranty Repair

You can request warranty repair service:

If a product does not function as warranted during the warranty period, you may obtain after-sales service by contacting SIYI's service center. You will need to provide a valid proof-of-purchase, receipt, or order number for the warranty service.

Charges may apply for services not covered by this Limited Warranty. Please contact SIYI for information specific to your location.

Please note that the warranty service is only available in the respective SIYI service regions where you purchased your SIYI product.

Warranty Repair service will not be provided where:

Crashes or fire damage caused by non-manufacturing factors, including but not limited to pilot errors.

Damage caused by unauthorized modification, disassembly, or shell opening not in accordance with official instructions or manuals.

Damage caused by improper installation, in correct use, or operation not in accordance with official instructions or manuals.

Damage caused by non-authorized service provider.

Damage caused by unauthorized modification of circuits and mismatch or misuse of the battery and charger.

Damage caused by operation in bad weather (i.e., strong winds, rain, sand/dust storms, etc.)

Damage caused by operating the product in an environment with electromagnetic interference (i.e., in mining areas or close to radio transmission towers, high-voltage wires, substations, etc.)

Damage caused by operating the product in an environment suffering from interference from other wireless devices (i.e., transmitter, video-downlink, Wi-Fi signals, etc.)

Damage caused by reliability or compatibility issues when using unauthorized third-party parts.

Damage caused by operating the unit with a low-charged or defective battery.

Products or parts with an altered identification label or from which the identification label has been removed.

SIYI Technology (Shenzhen) Co., Ltd

Business Inquiry: info@siyi.biz

Phone: +86 400 838 2918

A/S Center: support@siyi.biz