

# UP 4000

---

Maker Board  
UP-APL03

User's Manual 2nd Ed

## Copyright Notice

---

This document is copyrighted, 2022. All rights are reserved. The original manufacturer reserves the right to make improvements to the products described in this manual at any time without notice.

No part of this manual may be reproduced, copied, translated, or transmitted in any form or by any means without the prior written permission of the original manufacturer. Information provided in this manual is intended to be accurate and reliable. However, the original manufacturer assumes no responsibility for its use, or for any infringements upon the rights of third parties that may result from its use.

The material in this document is for product information only and is subject to change without notice. While reasonable efforts have been made in the preparation of this document to assure its accuracy, AAEMON assumes no liabilities resulting from errors or omissions in this document, or from the use of the information contained herein.

AAEMON reserves the right to make changes in the product design without notice to its users.

## Acknowledgement

---

All other products' name or trademarks are properties of their respective owners.

- Microsoft®, Windows® are registered trademarks of Microsoft Corp.
- Intel®, Pentium®, and Celeron® are registered trademarks of Intel Corporation
- Intel Atom™ is a trademark of Intel Corporation
- ITE is a trademark of Integrated Technology Express, Inc.

All other product names or trademarks are properties of their respective owners.

## Packing List

---

Before setting up your product, please make sure the following items have been shipped:

Item	Quantity
● UP-APL03 (UP 4000) with heatsink	1

If any of these items are missing or damaged, please contact your distributor or sales representative immediately.

## About this Document

---

This User's Manual contains all the essential information, such as detailed descriptions and explanations on the product's hardware and software features (if any), its specifications, dimensions, jumper/connector settings/definitions, and driver installation instructions (if any), to facilitate users in setting up their product.

Users may refer to the product page at [AAEON.com](http://AAEON.com) for the latest version of this document.

## Safety Precautions

---

Please read the following safety instructions carefully. It is advised that you keep this manual for future references

1. All cautions and warnings on the device should be noted.
2. Make sure the power source matches the power rating of the device.
3. Position the power cord so that people cannot step on it. Do not place anything over the power cord.
4. Always completely disconnect the power before working on the system's hardware.
5. No connections should be made when the system is powered as a sudden rush of power may damage sensitive electronic components.
6. If the device is not to be used for a long time, disconnect it from the power supply to avoid damage by transient over-voltage.
7. Always disconnect this device from any AC supply before cleaning.
8. While cleaning, use a damp cloth instead of liquid or spray detergents.
9. Make sure the device is installed near a power outlet and is easily accessible.
10. Keep this device away from humidity.
11. Place the device on a solid surface during installation to prevent falls
12. Do not cover the openings on the device to ensure optimal heat dissipation.
13. Watch out for high temperatures when the system is running.
14. Do not touch the heat sink or heat spreader when the system is running
15. Never pour any liquid into the openings. This could cause fire or electric shock.
16. As most electronic components are sensitive to static electrical charge, be sure to ground yourself to prevent static charge when installing the internal components. Use a grounding wrist strap and contain all electronic components in any static-shielded containers.

17. If any of the following situations arises, please the contact our service personnel:
  - i. Damaged power cord or plug
  - ii. Liquid intrusion to the device
  - iii. Exposure to moisture
  - iv. Device is not working as expected or in a manner as described in this manual
  - v. The device is dropped or damaged
  - vi. Any obvious signs of damage displayed on the device
  
18. **DO NOT LEAVE THIS DEVICE IN AN UNCONTROLLED ENVIRONMENT WITH TEMPERATURES BEYOND THE DEVICE'S PERMITTED STORAGE TEMPERATURES (SEE CHAPTER 1) TO PREVENT DAMAGE.**

### **Warning!**



This device complies with Part 15 FCC Rules. Operation is subject to the following two conditions: (1) this device may not cause harmful interference, and (2) this device must accept any interference received including interference that may cause undesired operation.

### **Caution:**

*There is a danger of explosion if the battery is incorrectly replaced. Replace only with the same or equivalent type recommended by the manufacturer. Dispose of used batteries according to the manufacturer's instructions and your local government's recycling or disposal directives.*

### **Attention:**

*Il y a un risque d'explosion si la batterie est remplacée de façon incorrecte. Ne la remplacer qu'avec le même modèle ou équivalent recommandé par le constructeur. Recycler les batteries usées en accord avec les instructions du fabricant et les directives gouvernementales de recyclage.*



## China RoHS Requirements (CN)

产品中有毒有害物质或元素名称及含量

AAEON Main Board/ Daughter Board/ Backplane

部件名称	有毒有害物质或元素					
	铅 (Pb)	汞 (Hg)	镉 (Cd)	六价铬 (Cr(VI))	多溴联苯 (PBB)	多溴二苯醚 (PBDE)
印刷电路板 及其电子组件	X	X	○	○	○	○
外部信号 连接器及线材	X	X	○	○	○	○
<p>○: 表示该有毒有害物质在该部件所有均质材料中的含量均在 SJ/T 11363-2006 标准规定的限量要求以下。</p> <p>X: 表示该有毒有害物质至少在该部件的某一均质材料中的含量超出 SJ/T 11363-2006 标准规定的限量要求。</p> <p>备注: 此产品所标示之环保使用期限, 系指在一般正常使用状况下。</p>						

## China RoHS Requirement (EN)

Poisonous or Hazardous Substances or Elements in Products

AAEON Main Board/ Daughter Board/ Backplane

Component	Poisonous or Hazardous Substances or Elements					
	Lead (Pb)	Mercury (Hg)	Cadmium (Cd)	Hexavalent Chromium (Cr(VI))	Polybrominated Biphenyls (PBB)	Polybrominated Diphenyl Ethers (PBDE)
PCB & Other Components	X	X	○	○	○	○
Wires & Connectors for External Connections	X	X	○	○	○	○
<p>○: The quantity of poisonous or hazardous substances or elements found in each of the component's parts is below the SJ/T 11363-2006-stipulated requirement.</p> <p>X: The quantity of poisonous or hazardous substances or elements found in at least one of the component's parts is beyond the SJ/T 11363-2006-stipulated requirement.</p> <p><b>Note:</b> The Environment Friendly Use Period as labeled on this product is applicable under normal usage only</p>						

# Table of Contents

---

<b>Chapter 1 - Product Specifications</b> .....	<b>1</b>
1.1 Specifications .....	2
<b>Chapter 2 – Hardware Information</b> .....	<b>4</b>
2.1 Dimensions .....	5
2.2 Jumpers and Connectors.....	6
2.3 List of Connectors.....	8
2.3.1 HAT 40 (CN1) .....	9
2.3.2 Programing Connector (CN2).....	10
2.3.3 Dual USB3.0 (CN4) .....	10
2.3.4 USB3.0 + HDMI (CN5).....	11
2.3.5 RJ45 (CN6).....	12
2.3.6 RTC Connector (CN9) .....	13
2.3.7 USB Type-C 3.0 (with DP Alt Mode) (CN10).....	13
2.3.8 DC Jack (CN11).....	14
2.3.9 USB / UART Pin Header (CN15) .....	15
2.3.10 Audio Connector (CN16).....	16
2.3.11 Power / Reset button (CN18).....	17
2.3.12 Fan Connector (CN19).....	17
2.3.13 High Speed Expnd Connector (CN21).....	18
2.3.14 Power Button (SW1).....	19
<b>Chapter 3 – Drivers Installation</b> .....	<b>20</b>
3.1 Driver Download and Installation.....	21
3.2 Unknown Device Troubleshooting.....	21
3.3 Dummy Driver Information .....	24
3.3.1 Dummy Driver Installation .....	24
3.3.2 Uninstalling the Dummy Driver .....	28

**Appendix A – UP Framework SDK Installation ..... 29**

- A.1 Introduction ..... 30
- A.2 Installation for Windows 10..... 30
- A.3 Installation for Windows IoT Core..... 33
- A.4 Windows IOT Audio Setting ..... 35

**Appendix B – Cables and Connectors ..... 36**

- B.1 Cables and Connectors..... 37

# Chapter 1

---

Product Specifications

## 1.1 Specifications

---

### System

<b>Processor</b>	Intel® Celeron® N3350/ Intel® Pentium® N4200/ Intel Atom® x7-E3950 Processor SoC
<b>Graphics</b>	Intel® Gen 9 HD, supporting 4K Codec Decode and Encode for HEVC4, H.264, VP8
<b>I/O</b>	HDMI x 1 2-pin wafer for Fan (12V) x 1 2-pin wafer for RTC Battery x 1 6-pin wafer for Audio (Line out + MIC) x 1 10-pin wafer for 2 USB2.0 + 1 HSUART x 1 HAT 40-pin header x 1 4-pin wafer for front panel x 1 FPC connector x 1
<b>Camera</b>	—
<b>USB</b>	USB 3.2 Gen 1 (Type-A) x 3 USB 2.0 pin header x 2 USB 3.2 Gen 1 (Type-C) x 1
<b>Expansion</b>	40-pin GPIO x 1 Via Carrier Board: M.2 2230/2242/2280 x 1 M.2 3052 x 1
<b>RTC</b>	Yes
<b>Power</b>	12V DC-in @5A (Phoenix Terminal optional)
<b>Dimension</b>	3.34" x 2.20" (85mm x 56mm)
<b>Memory</b>	On-board LPDDR4 max to 8GB
<b>Storage</b>	eMMC 16GB/ 32GB/ 64GB

## System

<b>Display Interface</b>	HDMI 1.4b x 1 DP 1.2 via USB Type C Connector
<b>Ethernet</b>	1 Gigabit Ethernet RJ-45 x 1 (full speed)
<b>OS Support</b>	Microsoft Windows 10 (full), Windows IOT Core Yocto project 3.1 (Kernel 5.4) Ubuntu 18.04
<b>Operating Temperature</b>	32°F ~ 140°F (0°C ~ 60°C) with 0.5m/s airflow
<b>Operation Humidity</b>	10% ~ 80% relative humidity, non-condensing
<b>Certification</b>	CE/FCC Class A, RoHS Compliant

# Chapter 2

---

Hardware Information



## 2.1 Dimensions

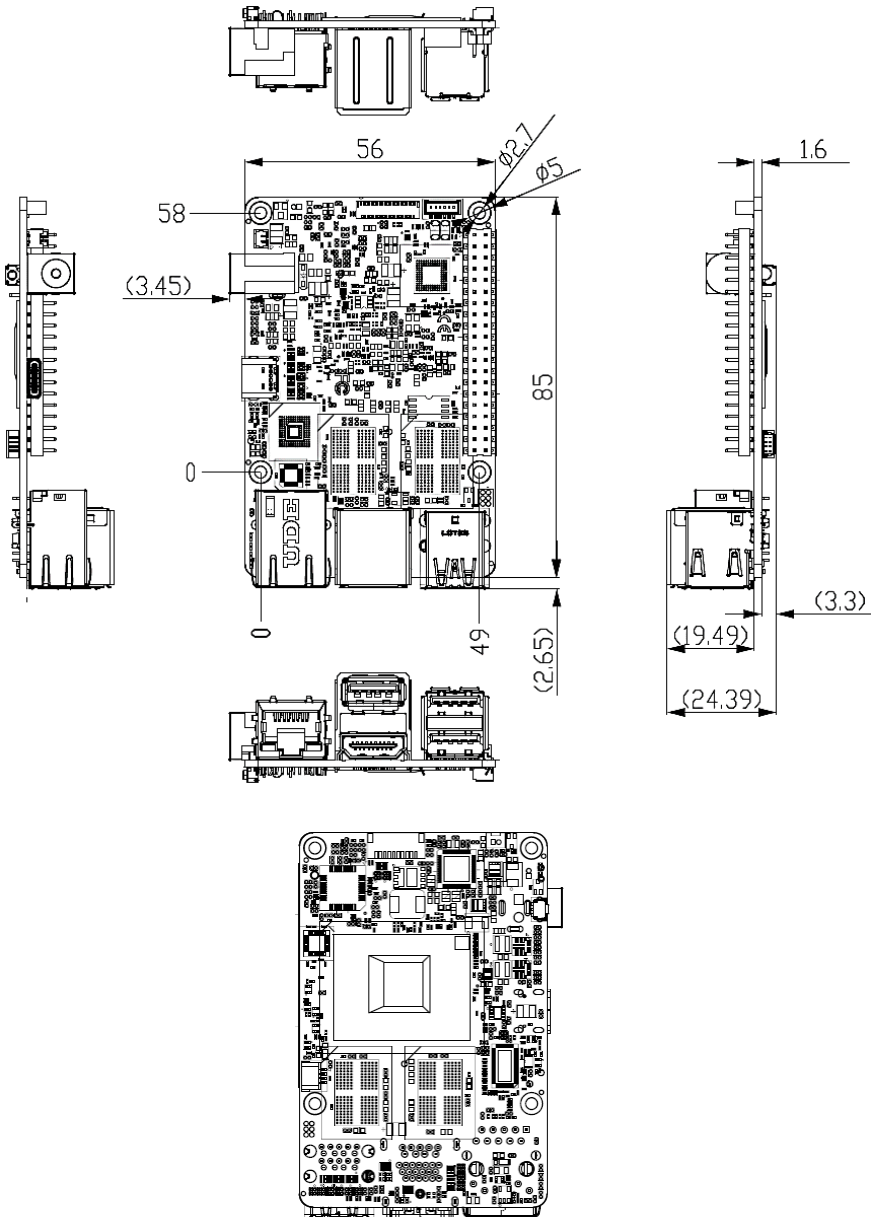

## 2.2 Jumpers and Connectors

Top:

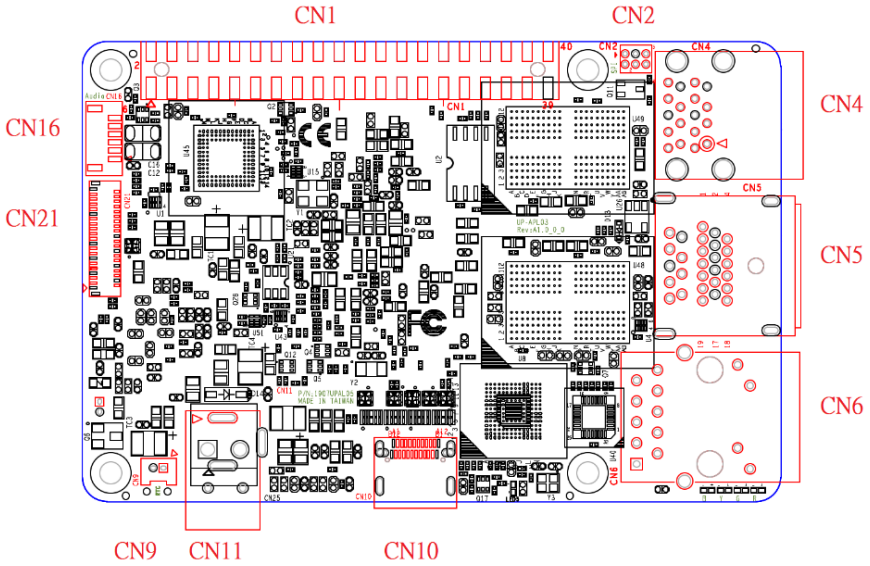

Bottom:

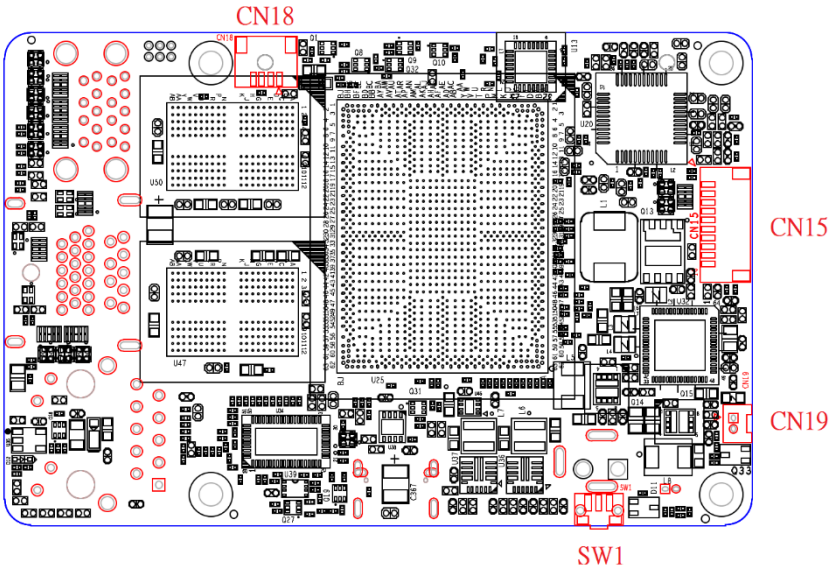

## 2.3 List of Connectors

---

Please refer to the table below for all of the board's connectors that you can configure for your application

Label	Function
CN1	HAT40
CN2	Programing Connector
CN4	Dual USB3.0
CN5	USB3.0 + HDMI
CN6	RJ45
CN9	RTC Connector
CN10	USB Type-C 3.0 (with DP Alt Mode)
CN11	DC Jack
CN15	USB Pin Header
CN16	Audio Connector.
CN18	Power / Reset button
CN19	FAN Connector
CN21	High Speed Expend Connector
SW1	Power Button

### 2.3.1 HAT 40 (CN1)

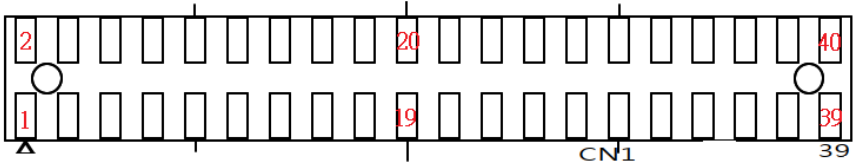

Pin	Signal	Pin	Signal
1	3.3V@0.5A	2	5V@0.5A
3	I2C1_SDA (GPIO 1)	4	5V@0.5A
5	I2C1_SCL (GPIO 2)	6	GND
7	GPIO_ADC (GPIO 3)	8	UART_TXD (GPIO 16)
9	GND	10	UART_RXD (GPIO 17)
11	UART_RTS (GPIO 4)	12	I2S_BCLK (GPIO 18)
13	GPIO 5	14	GND
15	GPIO 6	16	GPIO 19
17	3.3V@0.5A	18	GPIO 20
19	SPI_MOSI (GPIO 7)	20	GND
21	SPI_MISO (GPIO 8)	22	GPIO 21
23	SPI_CLK (GPIO 9)	24	SPI_FS0 (GPIO 22)
25	GND	26	SPI_FS1 (GPIO 23)
27	I2C0_SDA (GPIO 10)	28	I2C0_SCL (GPIO 24)
29	GPIO 11	30	GND
31	GPIO 12	32	PWM0 (GPIO 25)
33	PWM1 (GPIO 13)	34	GND
35	I2S_WS_SYNC (GPIO 14)	36	UART_CTS (GPIO 26)
37	GPIO 15	38	I2S_SDI (GPIO 27)
39	GND	40	I2S_SDO (GPIO 28)
H1	NC	H2	NC

### 2.3.2 Programming Connector (CN2)

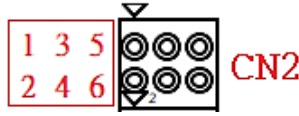

Pin	Signal	Pin	Signal
1	SPI_MISO	2	SPI_CLK
3	GND	4	SPI_CS0#
5	1.8V for SPI Flash	6	SPI_MOSI

### 2.3.3 Dual USB3.0 (CN4)

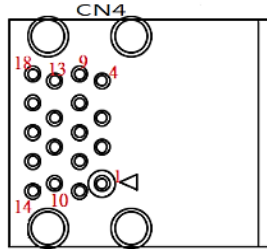

Pin	Signal	Pin	Signal
1	5V@0.9A for USB 3.0	2	USB2.0_DN0
3	USB2.0_DP0	4	GND
5	USB3.0_RXN_P0	6	USB3.0_RXP_P0
7	GND	8	USB3.0_TXN_P0
9	USB3.0_TXP_P0	10	5V@0.9A for USB 3.0
11	USB2.0_DN1	12	USB2.0_DP1
13	GND	14	USB3.0_RXN_P1
15	USB3.0_RXP_P1	16	GND

Pin	Signal	Pin	Signal
17	USB3.0_TXN_P1	18	USB3.0_TXP_P1
H1	GND	H2	GND
H3	GND	H4	GND

### 2.3.4 USB3.0 + HDMI (CN5)

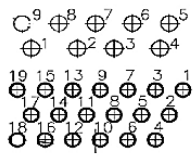
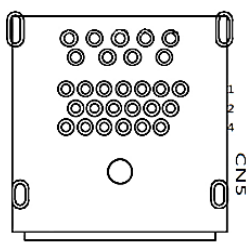

Pin	Signal	Pin	Signal
A1	HDMI_TMDS_TXP2	A2	GND
A3	HDMI_TMDS_TXN2	A4	HDMI_TMDS_TXP1
A5	GND	A6	HDMI_TMDS_TXN1
A7	HDMI_TMDS_TXP0	A8	GND
A9	HDMI_TMDS_TXN0	A10	HDMI_TMDS_Clock_P
A11	GND	A12	HDMI_TMDS_Clock_N
A13	NC	A14	NC
A15	HDMI_DDC_Clock	A16	HDMI_DDC_Data
A17	GND	A18	5V@1A for HDMI
A19	HDMI Hot Plug detect pin	-	-

Pin	Signal	Pin	Signal
H1	NC	H2	GND
H3	GND	H4	GND
H5	GND	-	-
B1	5V@0.9A for USB 3.0	B2	USB2.0_DN_P1
B3	USB2.0_DP_P1	B4	GND
B5	USB3.0_RxN_P1	B6	USB3.0_RxP_P1
B7	GND	B8	USB3.0_TxN_P1
B9	USB3.0_TxP_P1	-	-

### 2.3.5 RJ45 (CN6)

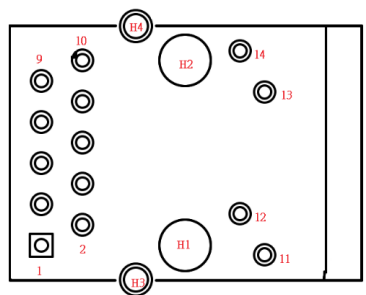

Pin	Signal	Pin	Signal
1	LAN1_MDI0+(TXD+)	2	LAN1_MDI0-(TXD-)
3	LAN1_MDI1+(RXD+)	4	LAN1_MDI1-(RXD-)
5	CT_GND	6	CT_GND
7	LAN1_MDI2+	8	LAN1_MDI2-
9	LAN1_MDI3+	10	LAN1_MDI3-
11	LAN Link LED 1000#	12	LAN Link LED 100#
13	LAN Active LED_N	14	LAN Active LED_P
H1	NC	H2	NC
H3	Chassis_GND	H4	Chassis_GND



### 2.3.6 RTC Connector (CN9)

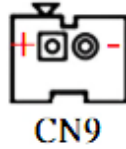

Pin	Signal	Pin	Signal
1	3.3V for RTC	2	GND

### 2.3.7 USB Type-C 3.0 (with DP Alt Mode) (CN10)

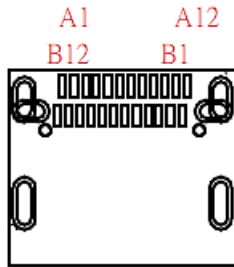

Pin	Signal	Pin	Signal
A1	GND	A2	USB3.0_Type-C_TxP_P1
A3	USB3.0_Type-C_TxN_P1	A4	5V@3A for USB Type-C
A5	USB Type-C CC pin1	A6	USB2.0_Type-C_DP_P1
A7	USB2.0_Type-C_DN_P1	A8	USB Type-C SBU1
A9	5V@3A for USB Type-C	A10	USB3.0_Type-C_RxP_P2
A11	USB3.0_Type-C_RxN_P2	A12	GND
B1	GND	B2	USB3.0_Type-C_TxP_P2
B3	USB3.0_Type-C_TxN_P2	B4	5V@3A for USB Type-C
B5	USB Type-C CC pin2	B6	USB2.0_Type-C_DP_P1

Pin	Signal	Pin	Signal
B7	USB2.0_Type-C_DN_P1	B8	USB Type-C SBU2
B9	5V@3A for USB Type-C	B10	USB3.0_Type-C_RxP_P1
B11	USB3.0_Type-C_RxN_P1	B12	GND
H1	NC	H2	NC
H3	GND	H4	GND
H5	GND	H6	GND
H7	GND	H8	GND

### 2.3.8 DC Jack (CN11)

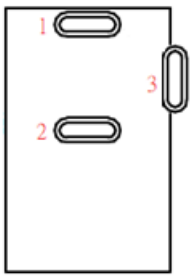

Pin	Signal	Pin	Signal
1	12V@7A Input	2	GND
3	GND	-	-

### 2.3.9 USB / UART Pin Header (CN15)

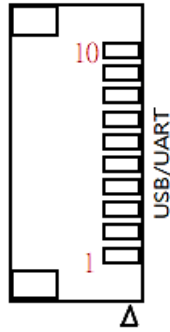

Pin	Signal	Pin	Signal
1	5V@0.5A for USB2.0	2	USB2.0_DN_P6
3	USB2.0_DP_P6	4	GND
5	5V@0.5A for USB2.0	6	USB2.0_DN_P7
7	USB2.0_DP_P7	8	GND
9	UART_RXD_3V3	10	UART_TXD_3V3
11	GND	12	GND

### 2.3.10 Audio Connector (CN16)



Pin	Signal	Pin	Signal
1	Audio Line Out - Right Channel	2	Audio Line Out - Left Channel
3	Audio_GND	4	Mic in detect pin (high active)-internal pull high to 5V
5	Line out detect pin (high active)-internal pull high to 5V	6	Mic in pin
7	Audio_GND	8	Audio_GND

**Note:** If pin 4 / pin 5 is not used, please keep it floating.

### 2.3.11 Power / Reset button (CN18)

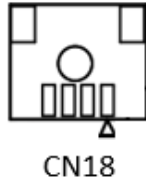

Pin	Signal	Pin	Signal
1	Power Button#	2	GND
3	Reset Button#	4	GND
5	GND	6	GND

### 2.3.12 Fan Connector (CN19)



Pin	Signal	Pin	Signal
1	Fan Power (12V via PWM control)	2	GND

### 2.3.13 High Speed Expand Connector (CN21)

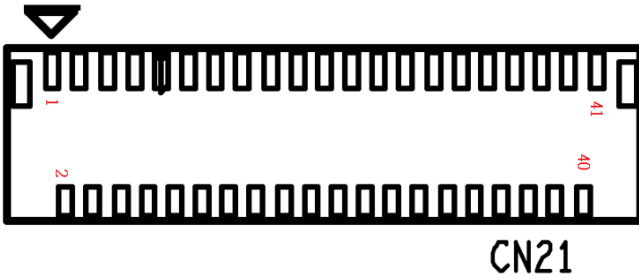

Pin	Signal	Pin	Signal
1	GND	2	PCIE_Clock_N_Port3
3	PCIE_Clock_P_Port3	4	GND
5	USB3.0_RxN	6	USB3.0_RxP
7	GND	8	USB3.0_TxN
9	USB3.0_TxP	10	GND
11	USB2.0_DN	12	USB2.0_DP
13	GND	14	PCIE_Clock_N_Port2
15	PCIE_Clock_P_Port2	16	GND
17	PCIE_RxP_P4	18	PCIE_RxN_P4
19	GND	20	PCIE_TxN_P4
21	PCIE_TxP_P4	22	GND
23	PCIe Wake_1.8V	24	Suspend Clock(32.768kHz)
25	SMBus_ALERT	26	SMBus_Clock
27	SMBus_Data	28	Platform reset#(3V3)
29	Sleep Control _S3#_3.3V	30	Sleep Control_S0#_3.3V
31	GND	32	1.8V@0.2A
33	1.8V@0.2A	34	12V@0.2A
35	12V@0.2A	36	12V@0.2A
37	12V@0.2A	38	12V@0.2A

Pin	Signal	Pin	Signal
39	12V@0.2A	40	12V@0.2A
41	GND	-	-
42	GND	43	GND

### 2.3.14 Power Button (SW1)

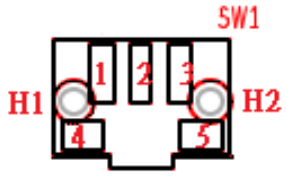

Pin	Signal	Pin	Signal
1	GND	2	Power Button#
3	GND	4	GND
5	GND	-	-
H1	GND	H2	GND

# Chapter 3

---

Drivers Installation



## 3.1 Driver Download and Installation

---

Please access <https://www.up-community.org> and go to the Downloads section > UP 4000 to find the relevant drivers.

## 3.2 Unknown Device Troubleshooting

---

After installing the drivers on Windows 10, you may see five unknown devices in the device manager. Follow the steps below to resolve each issue:

### Multimedia Audio Controller

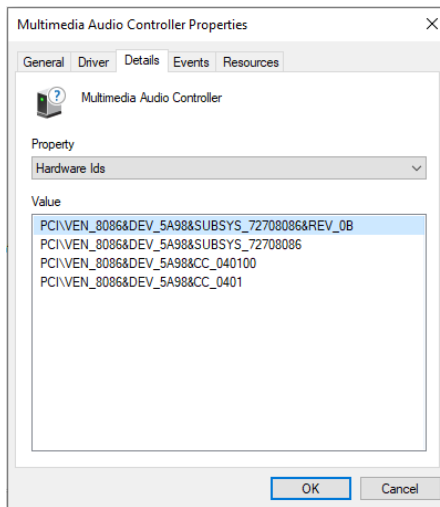

Go into the device BIOS Settings. Navigate the menus as follows:

**Chipset -> South Bridge -> HD-Audio Configuration**

Find **HD-Audio DSP** and change the setting to "disable."

### PCI Device (8086&DEV\_5AC8), Unknown Device (AANT0F01), and VEN\_AANT&DEV\_1280

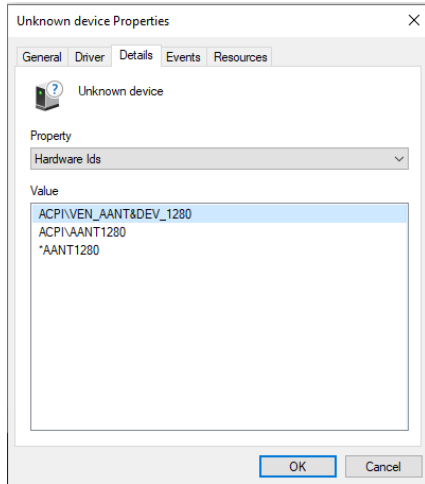
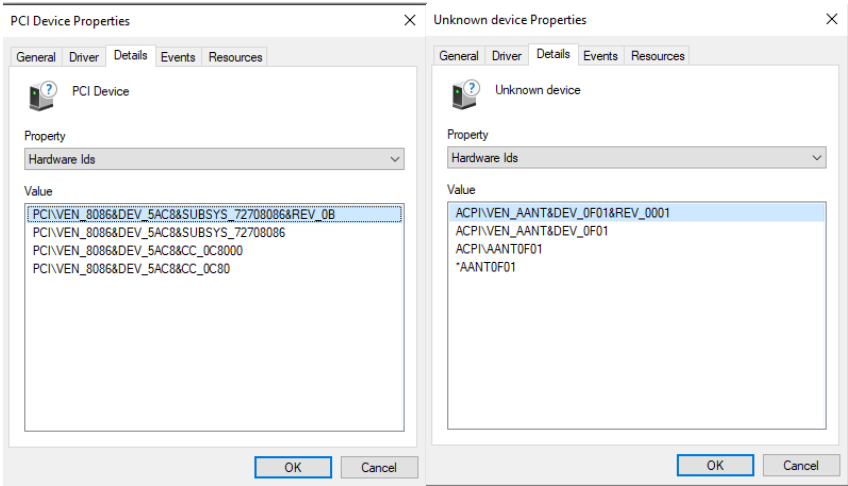

Go into the device BIOS Settings. Navigate to the **Boot** menu. Change **OS Selection** to "Windows."

**PCI Device:** The unknown PCI device is the PWM signal. It is provided directly from the Apollo Lake chipset, but Intel has not released a Windows driver for this device. This PCI device is not available for Windows 10, it is only supported by Linux.

**VEN\_AANT&DEV\_1280:** This is the ADC for Linux, there is no Windows driver. This can be ignored. (Note: error only occurs with Atom E3950 processor SoC)

**AANT0F04:** This is the FPGA device for Linux.

### USB OTG (Linux Only)

This refers to the USB OTG functionality on the USB Type-C port. There is no driver available for Windows 10. The function is only available on Linux.

- Go into the device BIOS Settings. Navigate the menus as follows:  
**Chipset -> South Bridge -> USB Configuration**
- Find USB VBUS and change setting to "Off", and change the XDCI Support setting to "PCI Mode".
- When the OTG function is enabled, Windows will have an unknown USB control (VEN\_8086&DEV5AAA).

## 3.3 Dummy Driver Information

---

### 3.3.1 Dummy Driver Installation

---

The following instructions detail how to install the dummy driver for your UP 4000 (UP-APL03).

#### Step 1 – Download UPNullDrv.msi.

 UPNullDrv.msi	10/17/2022 2:18 AM	Windows Installer Pa...	200 KB
---	--------------------	-------------------------	--------

**Step 2 – Click UPNullDrv.msi** and follow the steps as per the below images to install Driver.

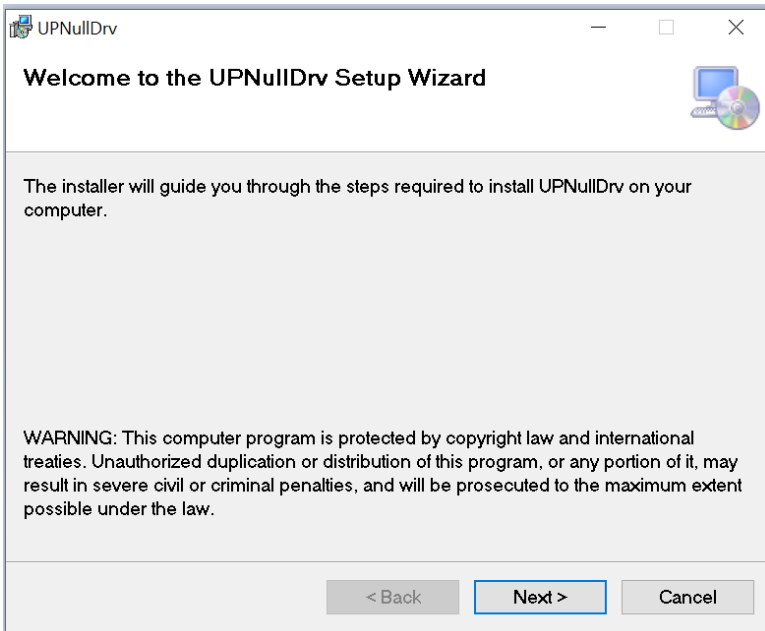

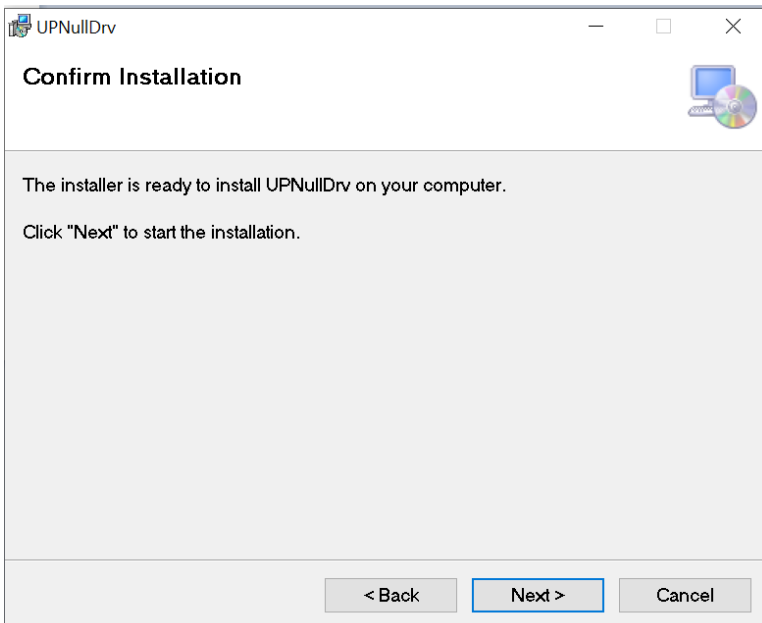
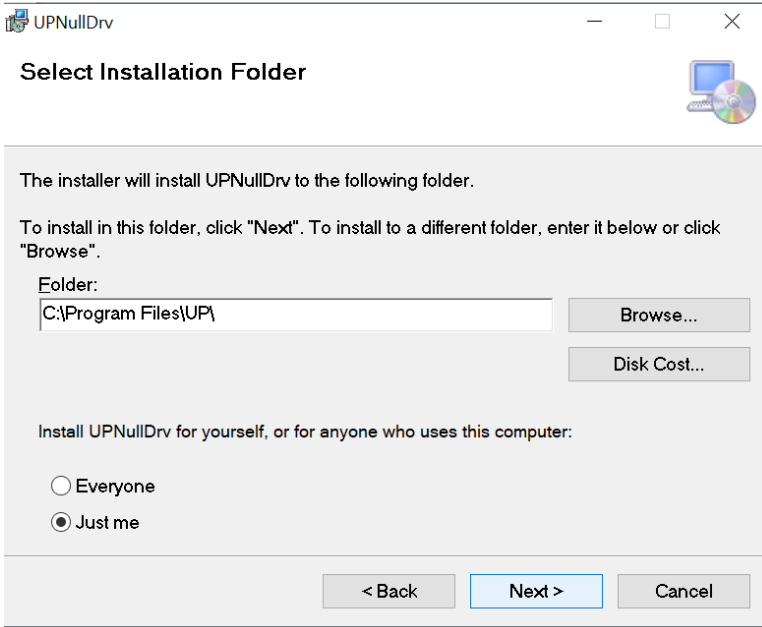

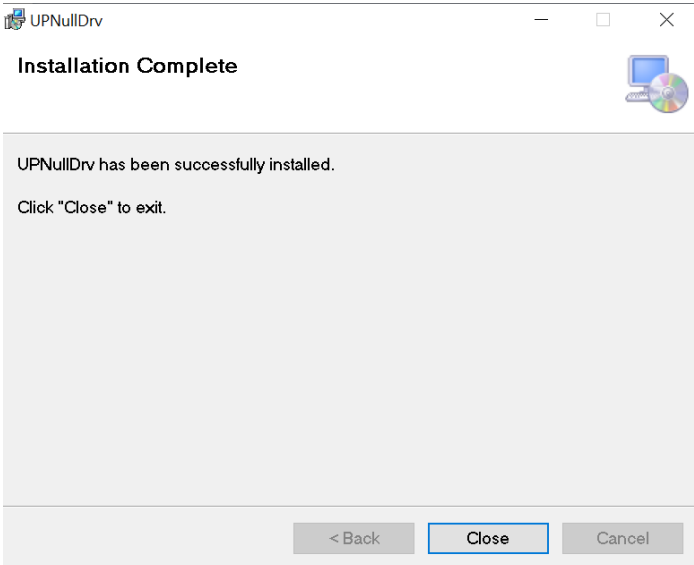
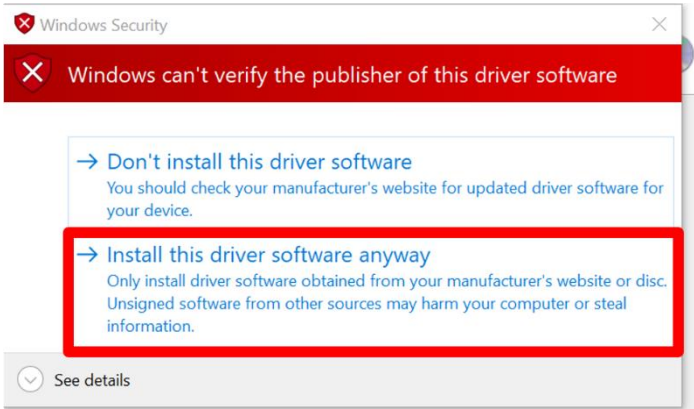

Once you have successfully installed the dummy driver, you will be able to locate it via your system's Device Manager, as shown below.

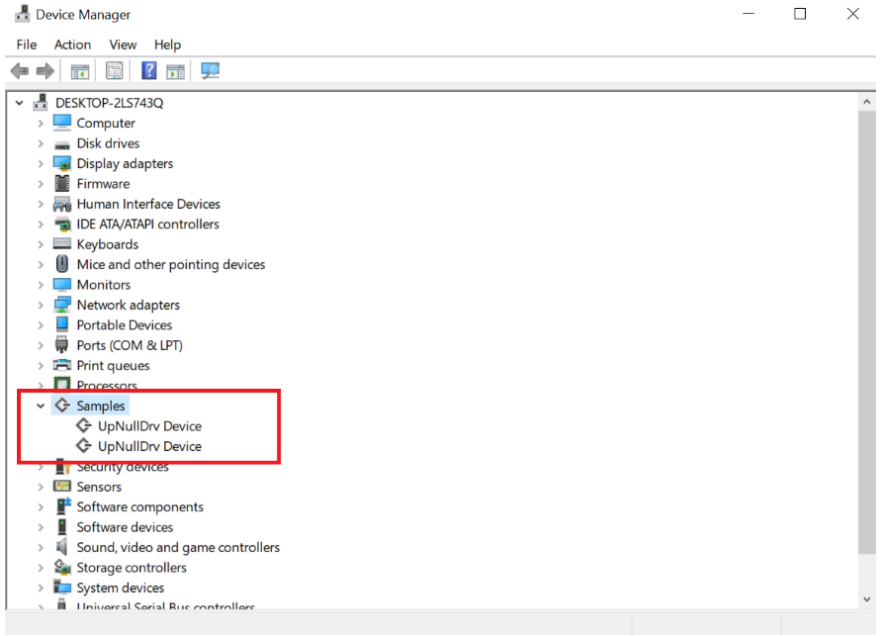

### 3.3.2 Uninstalling the Dummy Driver

Click **UPNullDrv.msi** to uninstall driver, then select **Remove UPNullDrv**.

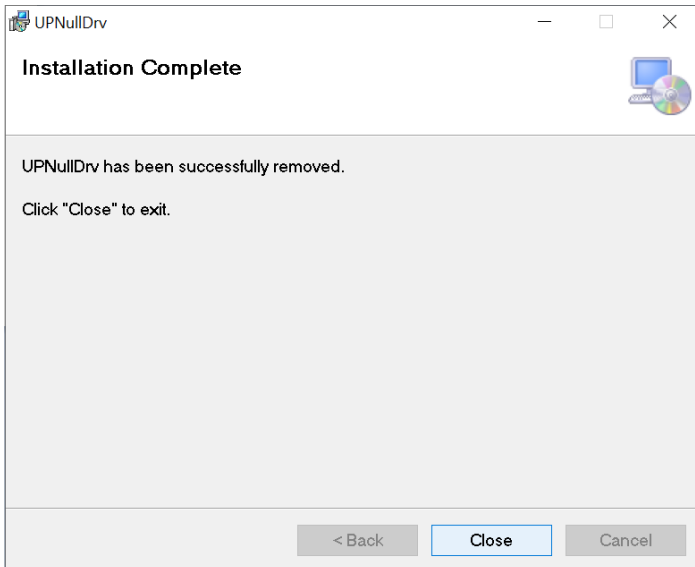
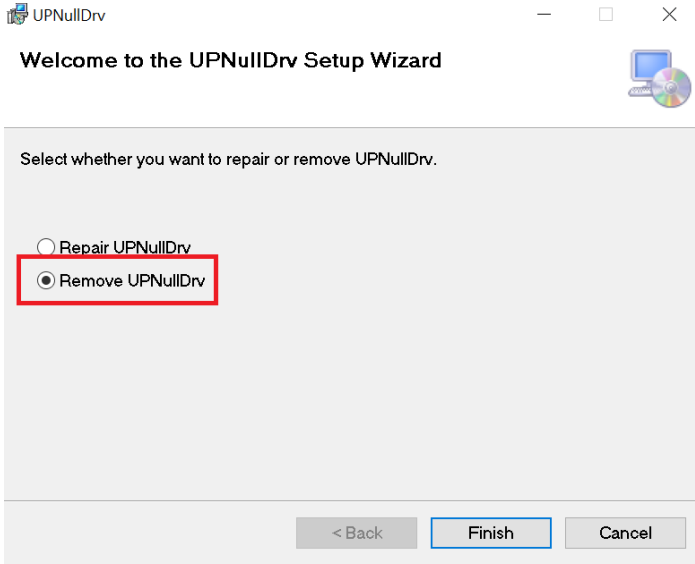



# Appendix A

---

UP Framework SDK Installation

## A.1 Introduction

---

This section provides instructions for the installation of the UP Framework SDK. Instructions are provided for Windows 10 and Windows IoT Core. You can download the latest version of UP Framework SDK from the UP community:

<https://downloads.up-community.org/download/up-sdk-for-windows-10-and-windows-iot/>

## A.2 Installation for Windows 10

---

### Step 1

Locate the downloaded file UpFrameworkSetup.msi and run the installer. Press “Next” to begin the setup process.

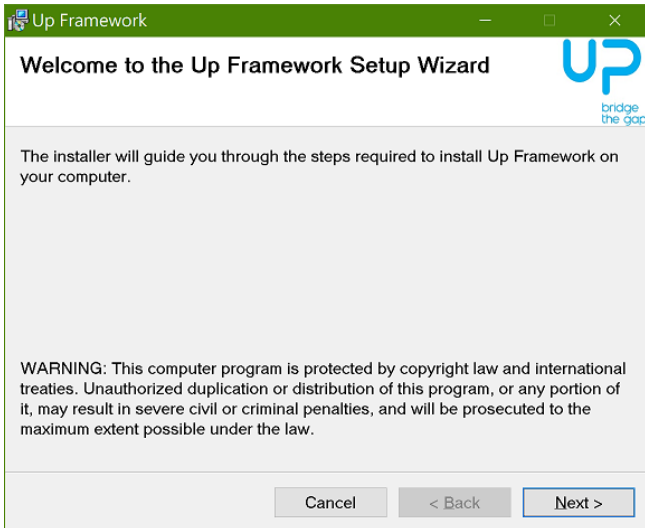

## Step 2

Select the installation folder. Default destination path is C:\Program Files(x86)\AAEON\  
You may also choose to install the UP Framework SDK for all users or only the current user. Press "Next" to continue installation.

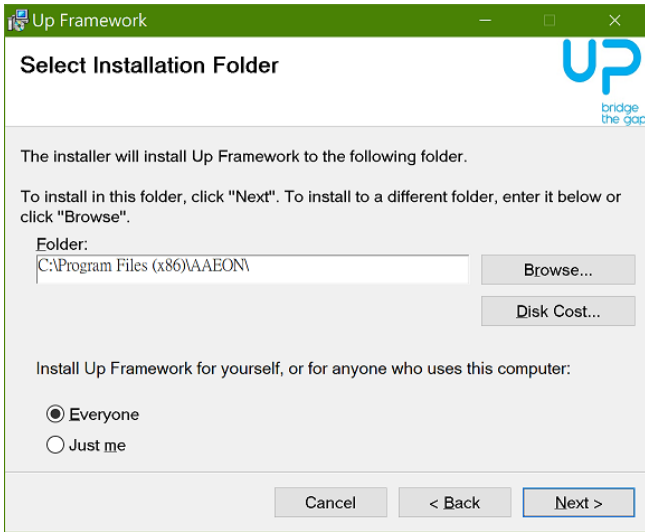

## Step 3

Press "Next" to confirm the installation.

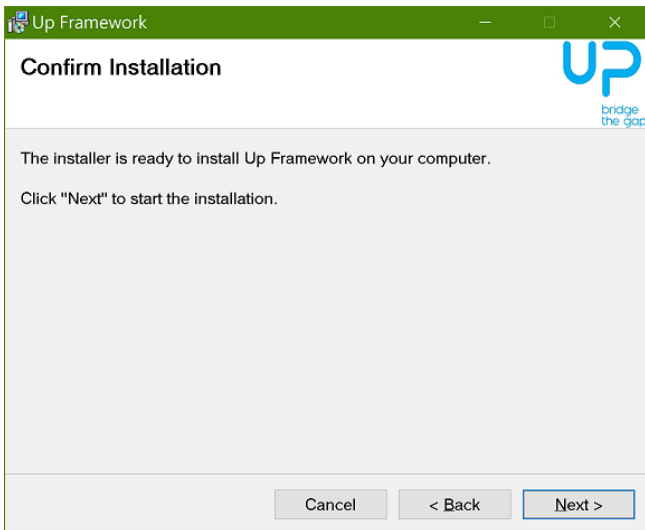

## Step 4

Press "Close" to exit once setup is complete.

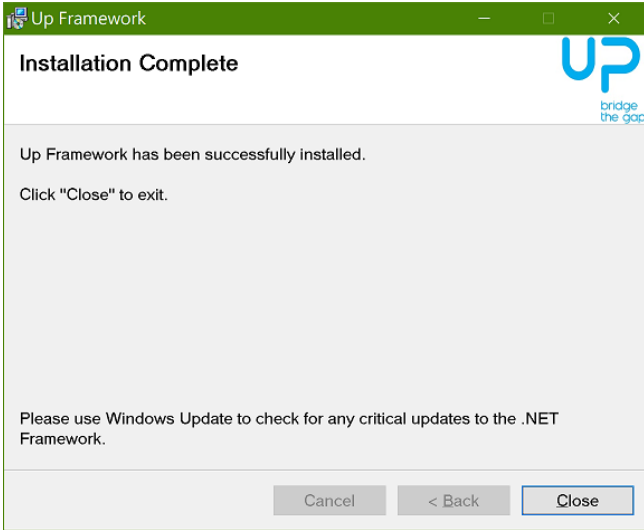

## A.3 Installation for Windows IoT Core

Before you begin, make sure you have downloaded and installed the latest version of the Windows IoT Core image from the UP community.

Installation requires using a connected PC with the UP Framework SDK software downloaded and saved. **Note:** Make sure the UP IoT Core device is connected to the same network as the PC you are using to install the software from.

### Step 1

Turn on your UP IoT Core device and note the IP address at the home screen.

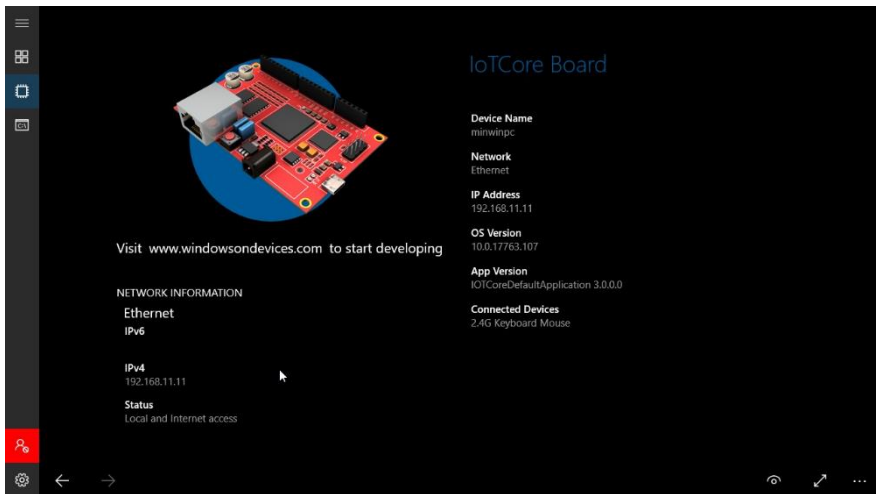

## Step 2

Download the UP Framework SDK to your PC and unzip the files.

Open PowerShell as an Administrator. Run the command

**RemoteInstallation.ps1** to install the UP Framework SDK.

Enter the IP address of the UP IoT Core device when prompted.

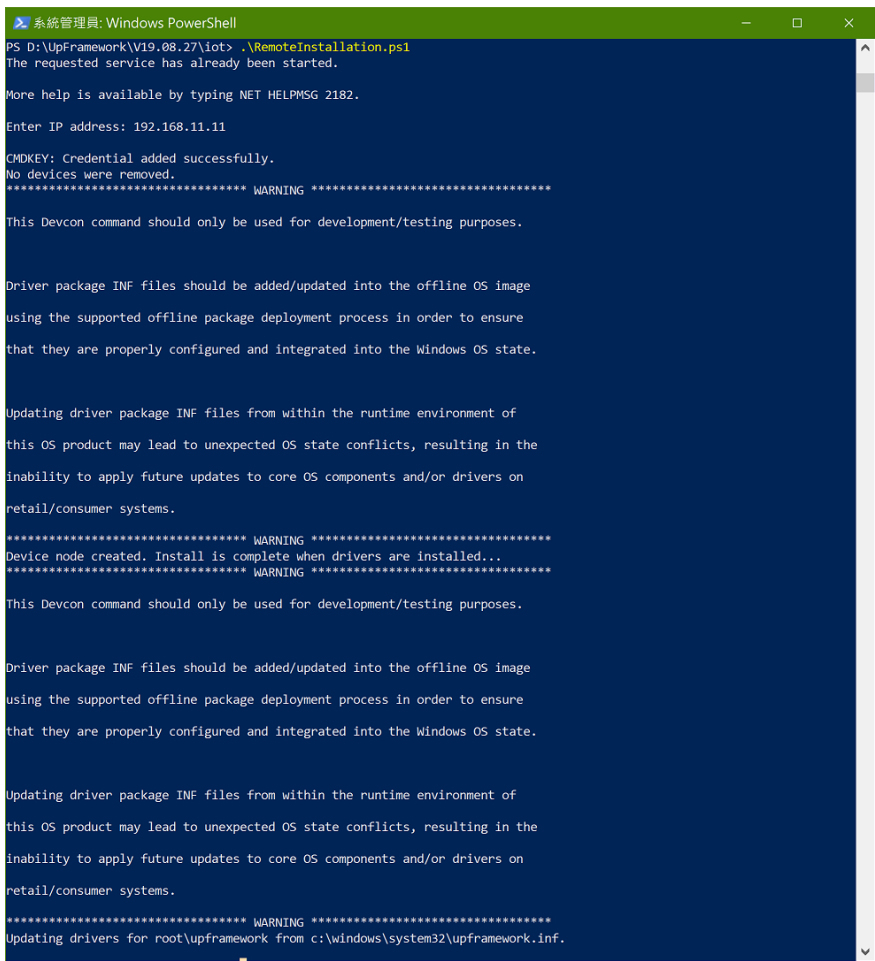

```
系統管理員: Windows PowerShell
PS D:\UpFramework\19.08.27\iot> .\RemoteInstallation.ps1
The requested service has already been started.

More help is available by typing NET HELPMSG 2182.

Enter IP address: 192.168.11.11

CMDKEY: Credential added successfully.
No devices were removed.
***** WARNING *****
This Devcon command should only be used for development/testing purposes.

Driver package INF files should be added/updated into the offline OS image
using the supported offline package deployment process in order to ensure
that they are properly configured and integrated into the Windows OS state.

Updating driver package INF files from within the runtime environment of
this OS product may lead to unexpected OS state conflicts, resulting in the
inability to apply future updates to core OS components and/or drivers on
retail/consumer systems.

***** WARNING *****
Device node created. Install is complete when drivers are installed...
***** WARNING *****
This Devcon command should only be used for development/testing purposes.

Driver package INF files should be added/updated into the offline OS image
using the supported offline package deployment process in order to ensure
that they are properly configured and integrated into the Windows OS state.

Updating driver package INF files from within the runtime environment of
this OS product may lead to unexpected OS state conflicts, resulting in the
inability to apply future updates to core OS components and/or drivers on
retail/consumer systems.

***** WARNING *****
Updating drivers for root\upframework from c:\windows\system32\upframework.inf.
```

## A.4 Windows IOT Audio Setting

---

To set up Windows IOT Audio Setting on your device, perform the instructions as follows.

- Open Command.
- Enter "IoTCoreAudioControlTool l" to see all Audio devices.
- Enter "IoTCoreAudioControlTool d {device number}" to switch devices.
- Here is an example of switching to HDMI.
- Enter "IoTCoreAudioControlTool d {0,0,0,00000000},{615fab44-fe40-4829-b91f-d67f07cfb98e}".
- Audio Line out will switch to HDMI

```
C:\> IoTCoreAudioControlTool l
,r,VZ249 (Intel(R) Display Audio),{0.0.0.00000000},{615fab44-fe40-4829-b91f-d67f07cfb98e},100.0
d,r,Speakers (High Definition Audio Device),{0.0.0.00000000},{eec7e9b8-4195-4ddf-975b-a42385c4c991},66.9
d,c,Microphone (High Definition Audio Device),{0.0.1.00000000},{de989f5e-b9c0-410e-9f8e-4b80d2fe5f8c},95.6
C:\> IoTCoreAudioControlTool d {0.0.0.00000000},{615fab44-fe40-4829-b91f-d67f07cfb98e}
```

# Appendix B

---

Cables and Connectors



## B.1 Cables and Connectors

This table provides detailed information about the cables and connectors used by the UP 4000 (UP-APL03). If you have any questions about the configuration of your board, please contact your AAEON sales representative.

Label	Connector	Function Description	Mating Cable PN	Mating Cable Description
CN9	1655X00019	RTC	175011301K	Lithium Battery.CR2032H.3V.240m AH.w/cable 90mm.DIP.Battery power.BP-CR2032-M90-001
CN16	1655906033	Audio	170X000382	Cable.6PPitch=1.0mm.150mm.FLYINGWAY.FWAA-1473.Audio Jack Cable
CN21	1654904130	High speed expansion	170X000542	FPC Cable.41PPitch=0.3mm.43.5*12.6*0.2mm.for UP-APL03
CN18	1655X00040	Power / Reset button	170X000543	Cable.4PSWITCH CABLE.200mm.FLYINGWAY.FWAA-1561
CN15	1655X00031	USB 2.0 / UART	170010015G	USB Cable.10P 1.0mm Housing.USB A(F).15cm