

V2.0

CREALITY

MANUAL

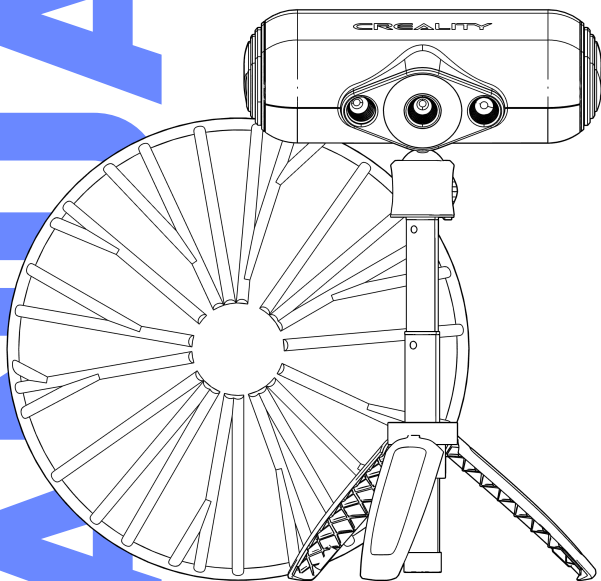

## CR-Scan Lizard

Hardware Connection **P1**

Packing List **P3**

Download latest **CRStudio** from  
<https://www.creality.com/download>



### Computer Requirements

**Minimum** Intel Core i5 8th, 8GB RAM,  
MX250 GPU with 2GB VRAM

**Recommended** Intel Core i7 8th, 16GB RAM,  
NVIDIA1060 GPU with 4GB VRAM

# P1

# HARDWARE CONNECTION

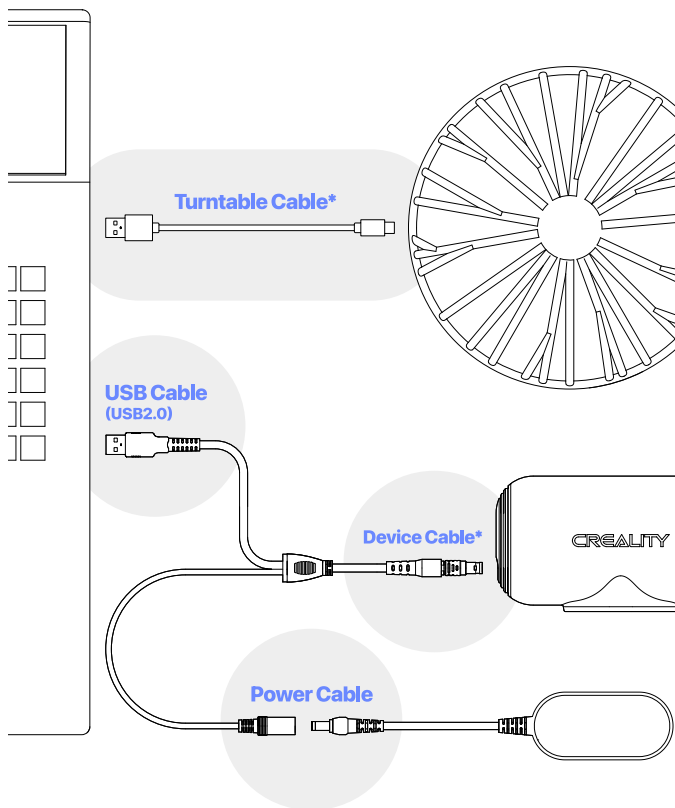

One end of the device is plugged into the navigation plug, and the other side is plugged into the power cord and computer USB 2.0 or above port respectively.

# P2

## \* Device Cable

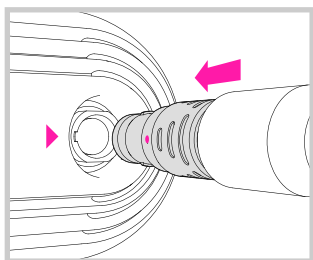

Align the airline plug of the device cable with the notch of the device jack.

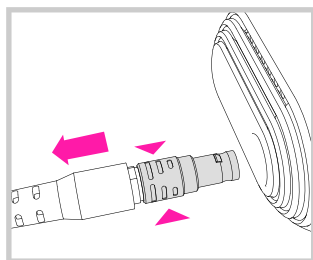

To unplug the cable, press and hold the position shown in the figure and pull out the cable directly.

## \* Turntable Cable

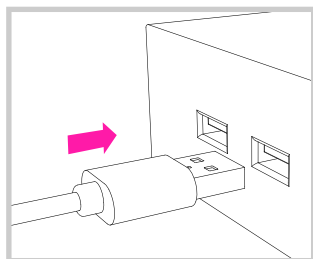
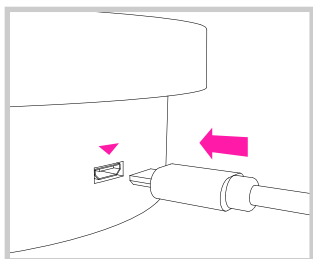

The turntable power cord can be plugged into the computer through usb power supply, or use the phone charger for its power supply.

# P3

# PACKING LIST

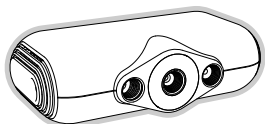

Host



USB Drive

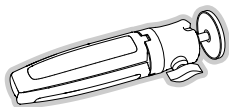

Tripod\*



Turntable\*

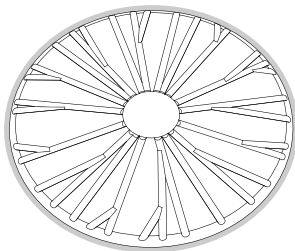

Turntable Surface\*



Manual

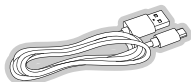

Turntable Cable\*

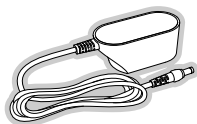

Power Supply

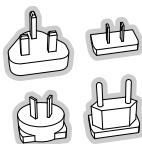

Changeover Plug

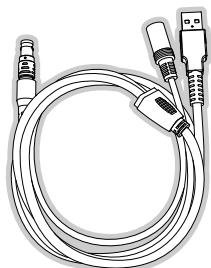

Device Cable

\* Not included in the base package.



To prevent antivirus software from blocking the driver, please uninstall the antivirus software.